

## XENPAK-DWDM-1537.40-80-A

10GBASE, DWDM, XENPAK, ER, (SM)

1528.77 NM - 1563.86 NM, 80 KM REACH, SC

## XENPAK-DWDM-1537.40-80-A

10GBASE, DWDM, XENPAK, ZR Transceiver

### Features

- Wavelength selectable to C-band ITU-T grid wavelengths
- Suitable for use in 100GHz channel spacing DWDM systems
- Support of IEEE 802.3ae 10GBASE-ER at 10.3125Gbps
- Transmission Distance up to 80Km(SMF)
- SC Receptacle DWDM Cooled EA Laser and APD photodiode
- SC Duplex Optical Connector
- Hot Pluggable 70-PIN Connector with XAUI Electrical Interface
- Management and control via MDIO 2-wire interface
- Power Supply : +5V, +3.3V, APS(+1.2V)
- Diagnostic Optics Monitoring
- Temperature Range: 0 - 70 °C
- ROHS Compatible



### Applications

- 10GE Ethernet switches and routers
- 10GE Core-routers
- 10GE Storage
- DWDM Systems

### 1. Product Description

The XENPAK-DWDM-1537.40-80-A is a highly integrated Serial optical transponder module for high-speed, 10Gbit/s data transmission applications. 4x3.125Gbps Ethernet Signal Input by XAUI Interface. An integrated Coder / Decoder and multiplexer / demultiplexer (SERDES: Serializer / Deserializer). Designing for 80km Transmission with an uncooled directly modulated DWDM Cooled EA-DFB Laser. Digital diagnostics functions are available via a 2-wire serial interface, as specified in the XENPAK MSA 3.0.

## 2. Absolute Maximum Ratings

Any stress beyond the maximum ratings can result in permanent damage. The device specifications are guaranteed only under the recommended operating conditions.

| Parameter                         | Symbol   | Min  | Max | Unit | Notes                   |
|-----------------------------------|----------|------|-----|------|-------------------------|
| Storage Ambient Temperature Range |          | -40  | +85 | °C   | Non Condensing          |
| Powered case Temperature Range    |          | 0    | +70 | °C   | Non Condensing          |
| Adaptable Power Supply (APS)      | Vapsense | 0    | 1.5 | V    | Voltage @ Pin APS Sense |
| Supply Voltage Range @ 3.3V       | Vcc3     | -0.5 | 4.0 | V    |                         |

## 3. Recommended Operating Conditions

| Parameter                  | Symbol | Min   | Typical | Max   | Unit |
|----------------------------|--------|-------|---------|-------|------|
| Operating Case Temperature | Tc     | 0     |         | +70   | °C   |
| Power Supply Voltage       | VCC5   | 4.75  | 5.0     | 5.25  | V    |
|                            | VCC3   | 3.14  | 3.3     | 3.47  |      |
|                            | VAPS   | 1.152 | 1.2     | 1.248 |      |
| Power Dissipation          | PD     |       |         | 4     | W    |

## 4. XAUI I/O Characteristics

| Parameter                         | Symbol | Min  | Typ   | Max  | Unit  | Notes                     |
|-----------------------------------|--------|------|-------|------|-------|---------------------------|
| XAUI Data Rate                    | DR     |      | 3.125 |      | Gb/s  |                           |
| XAUI Baud Rate Tolerance          |        | -100 |       | +100 | ppm   | Relative Tolerance        |
| Differential Input Voltage Swing  |        | 220  |       | 1600 | mv    | 8B/10B Coded Input Signal |
| Differential Output Voltage Swing |        | 800  |       | 1600 | mVp-p | RLOAD = 100Ω ±5%          |
| Differential Input Impedance      |        | 80   | 100   | 120  | Ω     |                           |
| Total Output Jitter               | TJXAUI |      |       | 0.35 | UI    | no pre-equalization       |
| Total Deterministic Output Jitter | DJXAUI |      |       | 0.17 | UI    | no pre-equalization       |

**5. Transmitter Characteristics**

| Parameter                           | Symbol      | Min               | Typ         | Max               | Unit    | Note |
|-------------------------------------|-------------|-------------------|-------------|-------------------|---------|------|
| Operating Range                     |             |                   |             | 80                | Km      |      |
| Operating Data Rate                 |             |                   | 10.3125     |                   | Gb/s    |      |
| Optical Transmit Power              | Po          | -1.0              |             | +2.0              | dBm     |      |
| Center Wavelength-Start of Life [1] | $\lambda_c$ | $\lambda_c - 25$  | $\lambda_c$ | $\lambda_c + 25$  | pm      |      |
| Center Wavelength-End of life [1]   | $\lambda_c$ | $\lambda_c - 100$ | $\lambda_c$ | $\lambda_c + 100$ | pm      |      |
| SMSR.                               | SWSR        | 30                |             |                   | dB      |      |
| Extinction Ratio                    | ER          | 9.0               |             |                   |         |      |
| Optical Modulation Amplitude        | OMA         | 500               |             |                   | $\mu$ W |      |
| Transmitter and Dispersion          |             |                   |             |                   |         |      |
| Penalty                             | TDP         |                   |             | 3.2               | dB      |      |

**6. Receiver Characteristics**

| Parameter                          | Symbol | Min | Typ     | Max   | Unit | Notes |
|------------------------------------|--------|-----|---------|-------|------|-------|
| Operating Data Rate                |        |     | 10.3125 |       | Gb/s |       |
| Overload                           | Po     | 0.5 |         |       | dBm  |       |
| Sensitivity in 10.3G(OMA)          | OMA0   |     |         | -23.5 | dBm  | 1     |
| Stressed Sensitivity in 10.3G(OMA) | OMAst  |     |         | -22.0 | dBm  | 1     |

**Notes**

1. Measured at 10.3125Gb/s, Non-framed PRBS2<sup>31</sup>-1, NRZ

**7. Electrical PAD Layout**

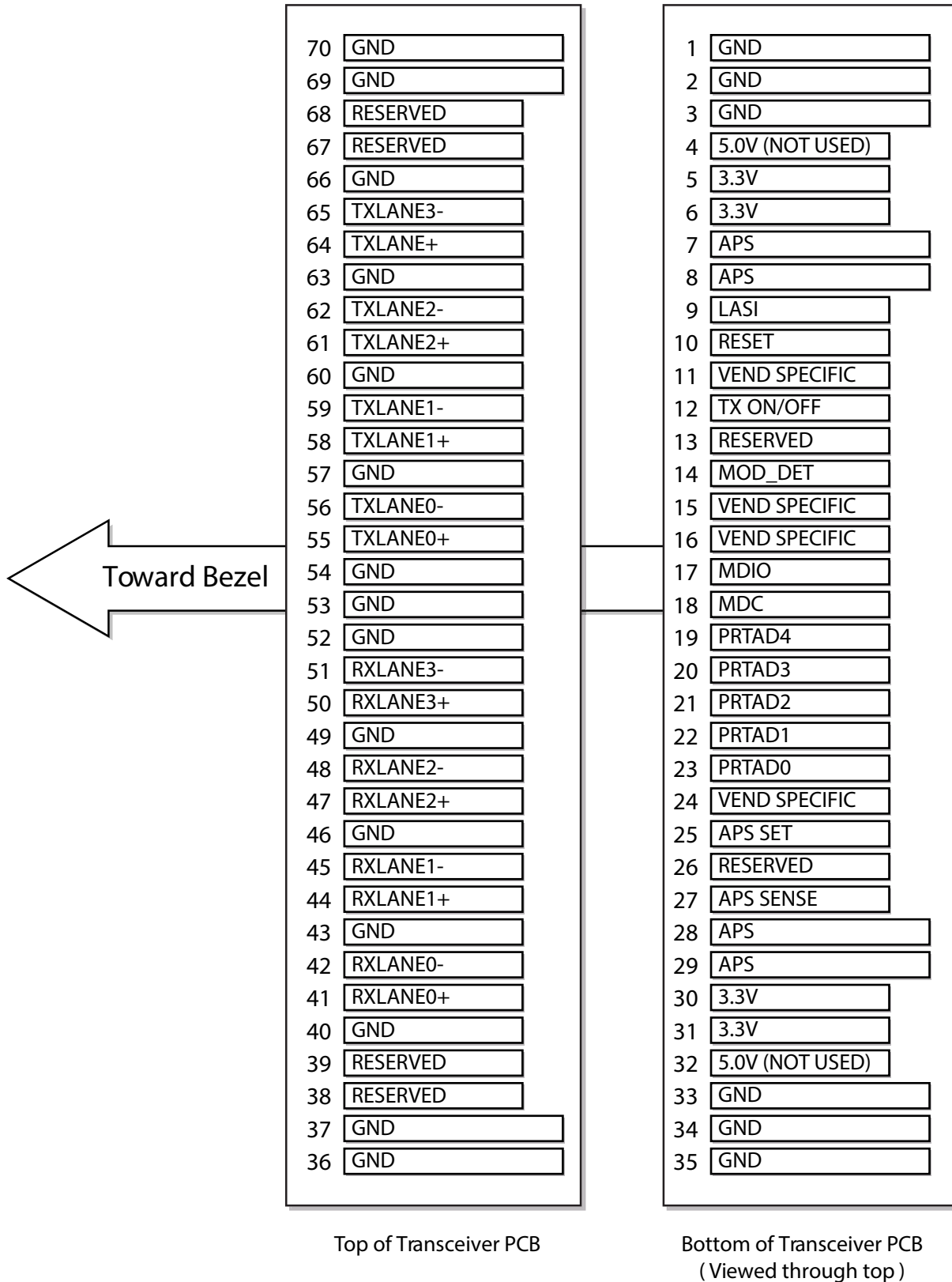



























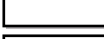
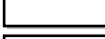
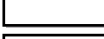
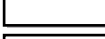
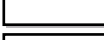
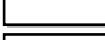
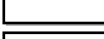
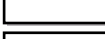
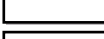
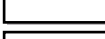
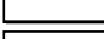
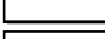
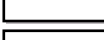
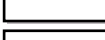
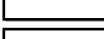
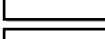
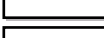
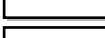
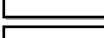
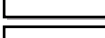
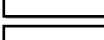
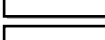
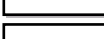
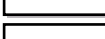
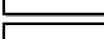
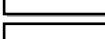
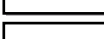
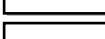

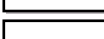
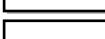
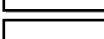
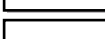
# XENPAK-DWDM-1537.40-80-A

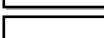
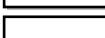
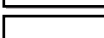
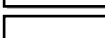
10GBASE, DWDM, XENPAK, ER, (SM)

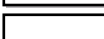
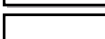
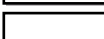
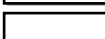
1528.77 NM - 1563.86 NM, 80 KM REACH, SC

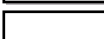
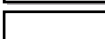
## 8. Host PCB XENPAK PINOUT

|    |   |                 |          |   |    |
|----|---|-----------------|----------|---|----|
| 1  |    | GND             | GND      |    | 70 |
| 2  |    | GND             | GND      |    | 69 |
| 3  |    | GND             | RESERVED |    | 68 |
| 4  |    | 5.0V (NOT USED) | RESERVED |    | 67 |
| 5  |    | 3.3V            | GND      |    | 66 |
| 6  |    | 3.3V            | TXLANE3- |    | 65 |
| 7  |    | APS             | TXLANE+  |    | 64 |
| 8  |    | APS             | GND      |    | 63 |
| 9  |    | LASI            | TXLANE2- |    | 62 |
| 10 |    | RESET           | TXLANE2+ |    | 61 |
| 11 |    | VEND SPECIFIC   | GND      |    | 60 |
| 12 |    | TX ON/OFF       | TXLANE1- |    | 59 |
| 13 |    | RESERVED        | TXLANE1+ |    | 58 |
| 14 |    | MOD_DET         | GND      |    | 57 |
| 15 |   | VEND SPECIFIC   | TXLANE0- |   | 56 |
| 16 |  | VEND SPECIFIC   | TXLANE0+ |  | 55 |
| 17 |  | MDIO            | GND      |  | 54 |
| 18 |  | MDC             | GND      |  | 53 |
| 19 |  | PRTAD4          | GND      |  | 52 |
| 20 |  | PRTAD3          | RXLANE3- |  | 51 |
| 21 |  | PRTAD2          | RXLANE3+ |  | 50 |
| 22 |  | PRTAD1          | GND      |  | 49 |
| 23 |  | PRTAD0          | RXLANE2- |  | 48 |
| 24 |  | VEND SPECIFIC   | RXLANE2+ |  | 47 |
| 25 |  | APS SET         | GND      |  | 46 |
| 26 |  | RESERVED        | RXLANE1- |  | 45 |
| 27 |  | APS SENSE       | RXLANE1+ |  | 44 |
| 28 |  | APS             | GND      |  | 43 |
| 29 |  | APS             | RXLANE0- |  | 42 |
| 30 |  | 3.3V            | RXLANE0+ |  | 41 |
| 31 |  | 3.3V            | GND      |  | 40 |
| 32 |  | 5.0V (NOT USED) | RESERVED |  | 39 |
| 33 |  | GND             | RESERVED |  | 38 |
| 34 |  | GND             | GND      |  | 37 |
| 35 |  | GND             | GND      |  | 36 |

**9. Pin Descriptions**

| Pin No | Name          | Dir | Function  | Notes |
|--------|---------------|-----|---|-------|
| 1      | GND           |     | Electrical Ground   |       |
| 2      | GND           |     | Electrical Ground   |       |
| 3      | GND           |     | Electrical Ground   |       |
| 4      | 5.0V          |     | Power   |       |
| 5      | 3.3V          |     | Power   |       |
| 6      | 3.3V          |     | Power   |       |
| 7      | APS =1.2V     |     | Adaptive Power Supply   |       |
| 8      | APS =1.2V     |     | Adaptive Power Supply   |       |
| 9      | LASI          |     | Open Drain Compatible 10K-22K pull up on host.<br>Logic High: Normal Operation<br>Logic Low: LASI Asserted                                |       |
| 10     | RESET         | I   | Open Drain compatible. 10-22K pull-up on transceiver<br>Logic high = Normal operation<br>Logic low = Reset Minimum reset assert time 1 ms |       |
| 11     | VEND SPECIFIC |     | Vendor Specific Pin.<br>Leave unconnected when not in use.  |       |
| 12     | TX ON/OFF     | I   | Open Drain compatible. 10-22K pull-up on transceiver<br>Logic high = Transmitter On (capable)<br>Logic low = Transmitter Off (always)     |       |
| 13     | RESERVED      |     | Reserved  |       |
| 14     | MOD DETECT    | O   | Pulled low inside module through 1k   |       |
| 15     | VEND SPECIFIC |     | Vendor Specific Pin.<br>Leave unconnected when not in use.  |       |
| 16     | VEND SPECIFIC |     | Vendor Specific Pin.<br>Leave unconnected when not in use.  |       |
| 17     | MDIO          | I/O | Management Data IO  |       |
| 18     | MDC           | I   | Management Data Clock   |       |
| 19     | PRTAD4        | I   | Port Address Bit 4 (Low = 0)  |       |
| 20     | PRTAD3        | I   | Port Address Bit 3 (Low = 0)  |       |
| 21     | PRTAD2        | I   | Port Address Bit 2 (Low = 0)  |       |
| 22     | PRTAD1        | I   | Port Address Bit 1  |       |
| 23     | PRTAD0        | I   | Port Address Bit 0 (Low = 0)  |       |
| 24     | VEND SPECIFIC |     | Vendor Specific Pin. Leave unconnected when not in use.   |       |
| 25     | APS SET       |     | Feedback input for APS  |       |
| 26     | RESERVED      |     | Reserved for Avalanche Photodiode use.  |       |
| 27     | APS SENSE     |     | APS Sense Connection  |       |

**XENPAK-DWDM-1537.40-80-A**

10GBASE, DWDM, XENPAK, ER, (SM)

1528.77 NM - 1563.86 NM, 80 KM REACH, SC

| Pin No | Name      | Dir | Function                   | Notes |
|--------|-----------|-----|----------------------------|-------|
| 28     | APS =1.2V |     | Adaptive Power Supply      |       |
| 29     | APS =1.2V |     | Adaptive Power Supply      |       |
| 30     | 3.3V      |     | Power                      |       |
| 31     | 3.3V      |     | Power                      |       |
| 32     | 5.0V      |     | Power                      |       |
| 33     | GND       |     | Electrical Ground          |       |
| 34     | GND       |     | Electrical Ground          |       |
| 35     | GND       |     | Electrical Ground          |       |
| 36     | GND       |     | Electrical Ground          |       |
| 37     | GND       |     | Electrical Ground          |       |
| 38     | RESERVED  |     | Reserved                   |       |
| 39     | RESERVED  |     | Reserved                   |       |
| 40     | GND       |     | Electrical Ground          |       |
| 41     | RX LANE0+ | O   | Module XAUI Output Lane 0+ |       |
| 42     | RX LANE0- | O   | Module XAUI Output Lane 0- |       |
| 43     | GND       |     | Electrical Ground          |       |
| 44     | RX LANE1+ | O   | Module XAUI Output Lane 1+ |       |
| 45     | RX LANE1- | O   | Module XAUI Output Lane 1- |       |
| 46     | GND       |     | Electrical Ground          |       |
| 47     | RX LANE2+ | O   | Module XAUI Output Lane 2+ |       |
| 48     | RX LANE2- | O   | Module XAUI Output Lane 2- |       |
| 49     | GND       |     | Electrical Ground          |       |
| 50     | RX LANE3+ | O   | Module XAUI Output Lane 3+ |       |
| 51     | RX LANE3- | O   | Module XAUI Output Lane 3- |       |
| 52     | GND       |     | Electrical Ground          |       |
| 53     | GND       |     | Electrical Ground          |       |
| 54     | GND       |     | Electrical Ground          |       |
| 55     | TX LANE0+ | I   | Module XAUI Input Lane 0+  |       |
| 56     | TX LANE0- | I   | Module XAUI Input Lane 0-  |       |
| 57     | GND       |     | Electrical Ground          |       |
| 58     | TX LANE1+ | I   | Module XAUI Input Lane 1+  |       |
| 59     | TX LANE1- | I   | Module XAUI Input Lane 1-  |       |
| 60     | GND       |     | Electrical Ground          |       |
| 61     | TX LANE2+ | I   | Module XAUI Input Lane 2+  |       |
| 62     | TX LANE2- | I   | Module XAUI Input Lane 2-  |       |
| 63     | GND       |     | Electrical Ground          |       |
| 64     | TX LANE3+ | I   | Module XAUI Input Lane 3+  |       |

# XENPAK-DWDM-1537.40-80-A

10GBASE, DWDM, XENPAK, ER, (SM)

1528.77 NM - 1563.86 NM, 80 KM REACH, SC

| Pin No | Name      | Dir | Function                  | Notes |
|--------|-----------|-----|---------------------------|-------|
| 65     | TX LANE3- | I   | Module XAUI Input Lane 3- |       |
| 66     | GND       |     | Electrical Ground         |       |
| 67     | RESERVED  |     | Reserved                  |       |
| 68     | RESERVED  |     | Reserved                  |       |
| 69     | GND       |     | Electrical Ground         |       |
| 70     | GND       |     | Electrical Ground         |       |

## 10. $\lambda_c$ Wavelength Guide

| TU Channel Product Code | Frequency (THz) | Wavelength | ITU Channel Product Code | Frequency (THz) | Wavelength |
|-------------------------|-----------------|------------|--------------------------|-----------------|------------|
| 17                      | 191.7           | 1563.86    | 40                       | 194.0           | 1545.32    |
| 18                      | 191.8           | 1563.04    | 41                       | 194.1           | 1544.52    |
| 19                      | 191.9           | 1562.23    | 42                       | 194.2           | 1543.73    |
| 20                      | 192.0           | 1561.41    | 43                       | 194.3           | 1542.93    |
| 21                      | 192.1           | 1560.60    | 44                       | 194.4           | 1542.14    |
| 22                      | 192.2           | 1559.79    | 45                       | 194.5           | 1541.34    |
| 23                      | 192.3           | 1558.98    | 46                       | 194.6           | 1540.55    |
| 24                      | 192.4           | 1558.17    | 47                       | 194.7           | 1539.76    |
| 25                      | 192.5           | 1557.36    | 48                       | 194.8           | 1538.97    |
| 26                      | 192.6           | 1556.55    | 49                       | 194.9           | 1538.19    |
| 27                      | 192.7           | 1555.74    | 50                       | 195.0           | 1537.40    |
| 28                      | 192.8           | 1554.94    | 51                       | 195.1           | 1536.61    |
| 29                      | 192.9           | 1554.13    | 52                       | 195.2           | 1535.82    |
| 30                      | 193.0           | 1553.32    | 53                       | 195.3           | 1535.04    |
| 31                      | 193.1           | 1552.52    | 54                       | 195.4           | 1534.25    |
| 32                      | 193.2           | 1551.72    | 55                       | 195.5           | 1533.46    |
| 33                      | 193.3           | 1550.92    | 56                       | 195.6           | 1532.68    |
| 34                      | 193.4           | 1550.11    | 57                       | 195.7           | 1531.89    |
| 35                      | 193.5           | 1549.32    | 58                       | 195.8           | 1531.12    |
| 36                      | 193.6           | 1548.51    | 59                       | 195.9           | 1530.33    |
| 37                      | 193.7           | 1547.71    | 60                       | 196.0           | 1529.55    |
| 38                      | 193.8           | 1546.92    | 61                       | 196.1           | 1528.77    |
| 39                      | 193.9           | 1546.12    | -                        | -               | -          |



**11. Block Diagram of Adapter Power Supply Circuit**

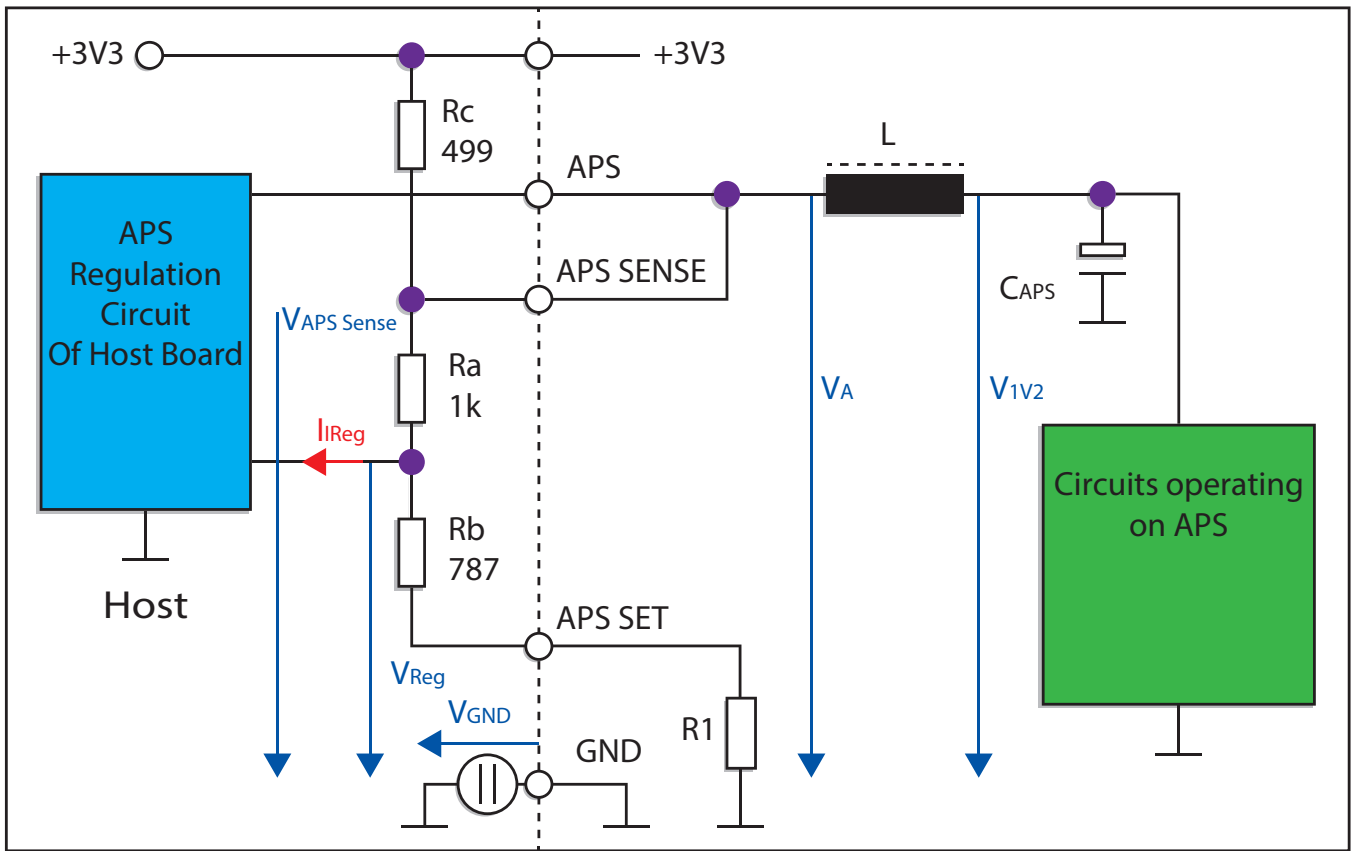

**12. Eye Safety**

This laser based multimode transceiver is a Class 1 product. It complies with IEC 60825-1 Ed.2: 2007 and FDA performance standards for laser products (21 CFR 1040.10 and 1040.11) except for deviations pursuant to Laser Notice 50, dated June 24, 2007.

# XENPAK-DWDM-1537.40-80-A

10GBASE, DWDM, XENPAK, ER, (SM)

1528.77 NM - 1563.86 NM, 80 KM REACH, SC

## 13. Package Outline

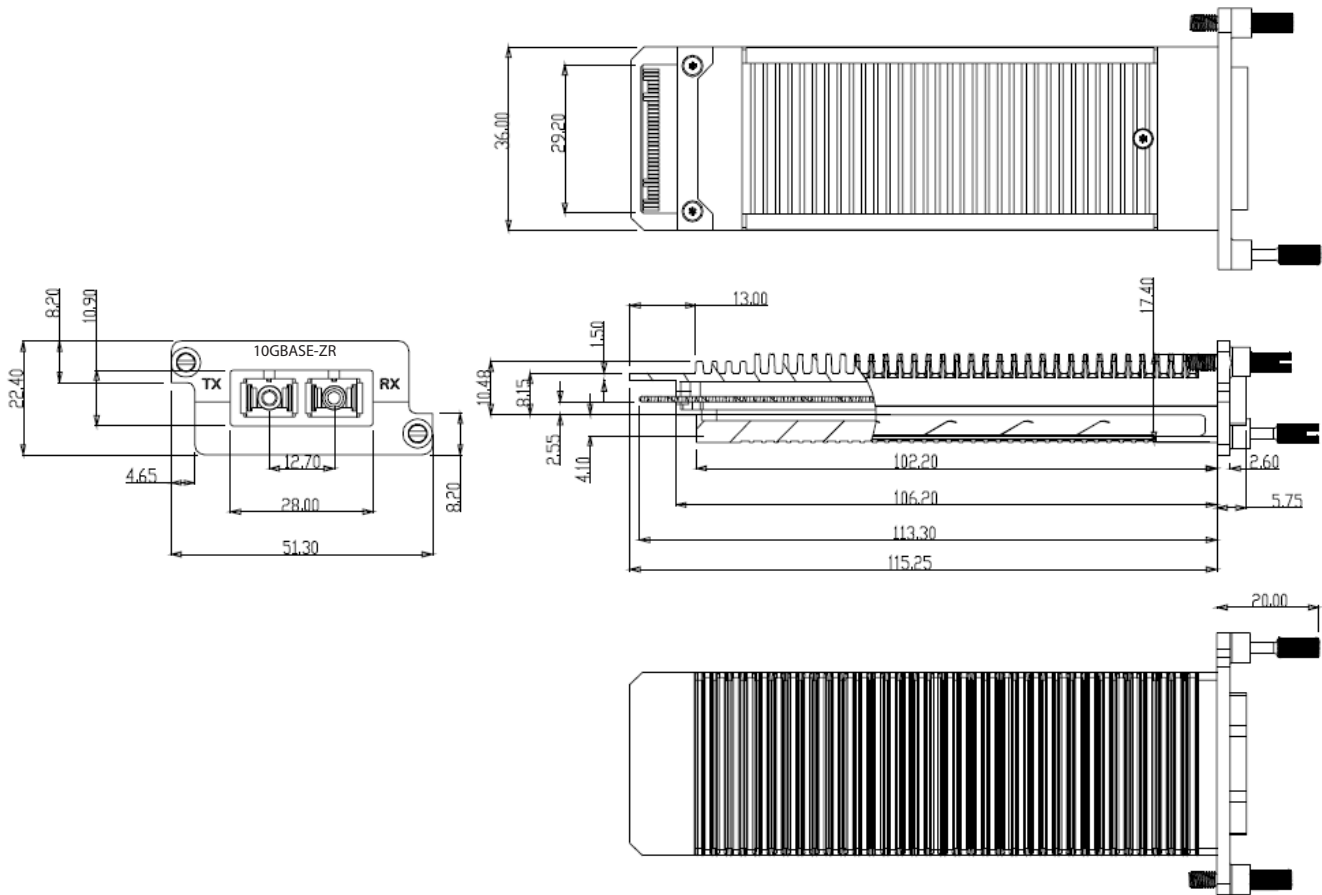

## 14. Contact Information

Approved Networks is a leading supplier of Network Transceivers and Connectivity products to Channel Partners, Resellers, and OEMs. With more than 9 years of direct industry experience, our products are resident in the most demanding and mission critical functional networks Worldwide. We serve as a Master Distributor to the largest CMs in the world and deploy the most rigorous testing and firmware management programs to bring the highest level of functional product to the market at a cost that makes sense.

Corporate Offices: **Approved Networks, Inc.**

Tel: 800.590.9535

Web: <http://www.approvednetworks.com>