

XENPAK-CWDM-1410-80-A

10GBASE, CWDM, XENPAK, ZR, (SM)
1470 NM - 1610 NM, 80 KM REACH, SC

XENPAK-CWDM-1410-80-A

10GBASE, CWDM, XENPAK, ZR Transceiver

Features

- Wavelength selectable to ITU-T standards covering CWDM grid
- Support of IEEE 802.3ae 10GBASE-ER at 10.3125Gbps
- Transmission Distance up to 80Km(SMF)
- SC Receptacle CWDM Cooled EA Laser and APD photodiode
- SC Duplex Optical Connector
- Hot Pluggable 70-PIN Connector with XAUI Electrical Interface
- Management and control via MDIO 2-wire interface
- Power Supply : +5V, +3.3V, APS(+1.2V)
- Diagnostic Optics Monitoring
- Temperature Range: 0 - 70 °C
- ROHS Compatible



Applications

- 10GE Ethernet switches and routers
- 10GE Core-routers
- 10GE Storage
- CWDM Systems

1. Product Description

The Approved Networks XENPAK-CWDM-1410-80-A is a highly integrated Serial optical transponder module for high-speed, 10Gbit/s data transmission applications. 4x3.125Gbps Ethernet Signal Input by XAUI Interface. An integrated Coder / Decoder and multiplexer / demultiplexer (SERDES: Serializer / Deserializer). Designing for 80km Transmission with an uncooled directly modulated CWDM Cooled EA-DFB Laser. Digital diagnostics functions are available via a 2-wire serial interface, as specified in the XENPAK MSA 3.0.

2. Absolute Maximum Ratings

Any stress beyond the maximum ratings can result in permanent damage. The device specifications are guaranteed only under the recommended operating conditions.

Parameter	Symbol	Min	Max	Unit	Notes
Storage Ambient Temperature Range		-40	+85	°C	Non Condensing
Powered case Temperature Range		0	+70	°C	Non Condensing
Adaptable Power Supply (APS)	Vapsense	0	1.5	V	Voltage @ Pin APS Sense
Supply Voltage Range @ 3.3V	Vcc3	-0.5	4.0	V	

3. Recommended Operating Conditions

Parameter	Symbol	Min	Typical	Max	Unit
Operating Case Temperature	Tc	0		+70	°C
Power Supply Voltage	VCC5	4.75	5.0	5.25	V
	VCC3	3.14	3.3	3.47	
	VAPS	1.152	1.2	1.248	
Power Dissipation	PD		3.5	4	W

4. XAUI I/O Characteristics

Parameter	Symbol	Min	Typ	Max	Unit	Notes
XAUI Data Rate	DR		3.125		Gb/s	
XAUI Baud Rate Tolerance		-100		+100	ppm	Relative Tolerance
Differential Input Voltage Swing		220		1600	mv	8B/10B Coded Input Signal
Differential Output Voltage Swing		800		1600	mVp-p	RLOAD = 100Ω ±5%
Differential Input Impedance		80	100	120	Ω	
Total Output Jitter	TJXAUI			0.35	UI	no pre-equalization
Total Deterministic Output Jitter	DJXAUI			0.17	UI	no pre-equalization

5. Transmitter Characteristics

Parameter	Symbol	Min	Typ	Max	Unit	Note
Operating Range				10	Km	
Operating Data Rate 1			0.3125		Gb/s	
Optical Transmit Power	P _o	-1.0		+2.0	dBm	
Output Centre Wavelength	λ _c	1470		1610	nm	
Center wavelength stability	Δλ _c	-6.5	λ _c	+6.5	nm	
SMSR	SWSR	30			dB	
Extinction Ratio	ER	9.0				
Optical Modulation Amplitude	OMA	500			μW	
Transmitter and Dispersion						
Penalty	TDP			3.2	dB	

6. Receiver Characteristics

Parameter	Symbol	Min	Typ	Max	Unit	Notes
Operating Data Rate			10.3125		Gb/s	
Overload	P _o	0.5			dBm	
Sensitivity in 10.3G(OMA)	OMA ₀			-23.5	dBm	1
Stressed Sensitivity in 10.3G(OMA)	OMA _{st}			-22.0	dBm	1

Notes

1. Measured at 10.3125Gb/s, Non-framed PRBS2³¹-1, NRZ



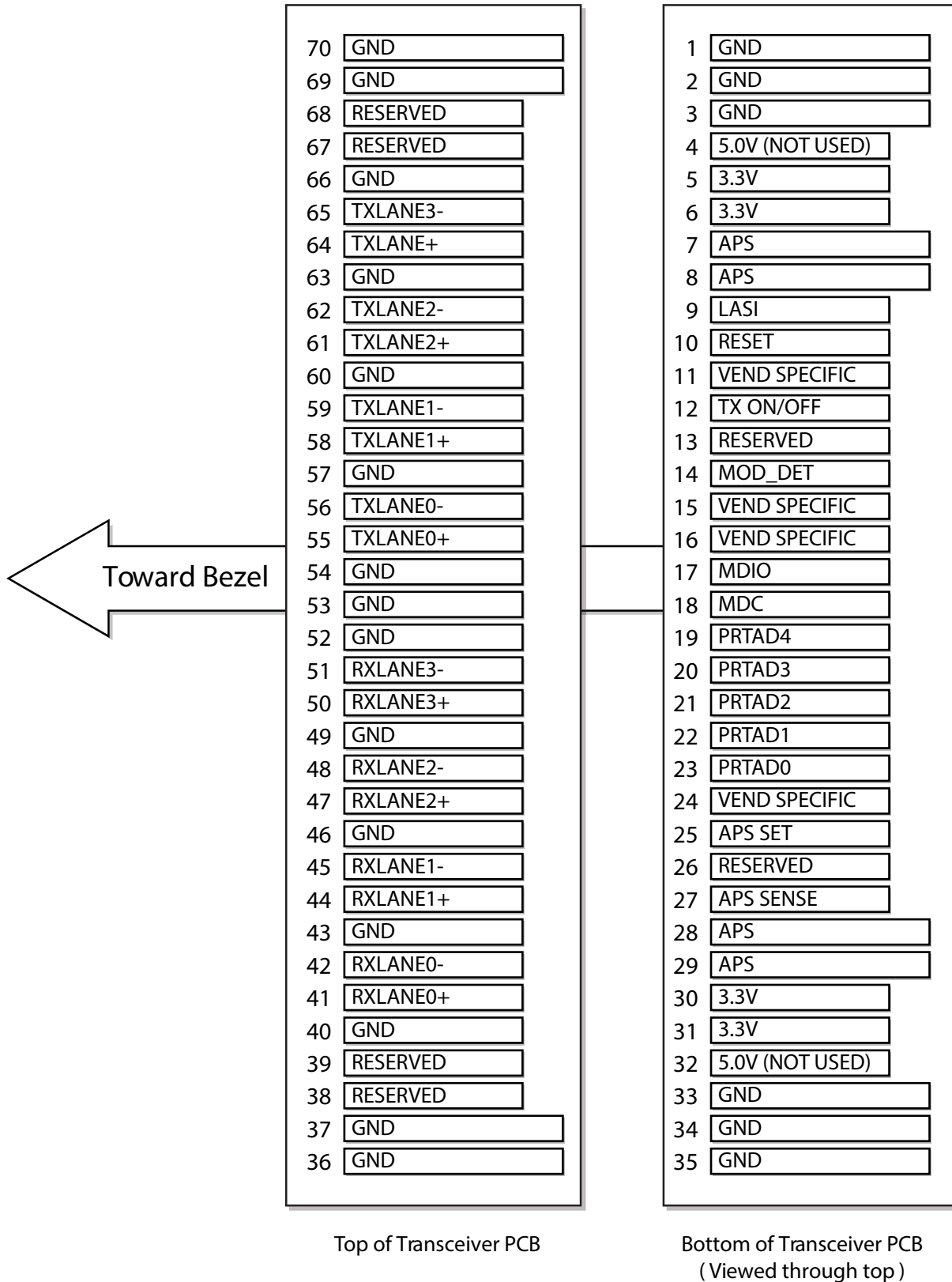























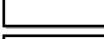
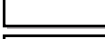
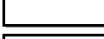
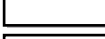
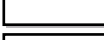
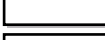
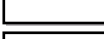
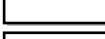
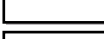
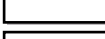
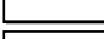
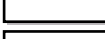
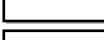
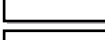
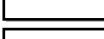
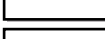
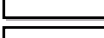
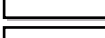
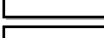
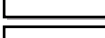
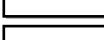
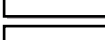
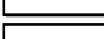
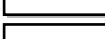
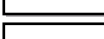
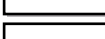
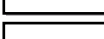
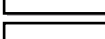

7. Electrical PAD Layout

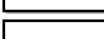
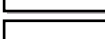
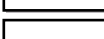
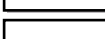

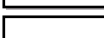
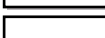
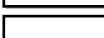
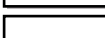
XENPAK-CWDM-1410-80-A

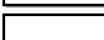
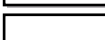
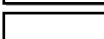
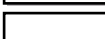
10GBASE, CWDM, XENPAK, ZR, (SM)
1470 NM - 1610 NM, 80 KM REACH, SC

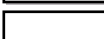
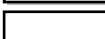
8. Host PCB XENPAK PINOUT

1		GND	GND		70
2		GND	GND		69
3		GND	RESERVED		68
4		5.0V (NOT USED)	RESERVED		67
5		3.3V	GND		66
6		3.3V	TXLANE3-		65
7		APS	TXLANE+		64
8		APS	GND		63
9		LASI	TXLANE2-		62
10		RESET	TXLANE2+		61
11		VEND SPECIFIC	GND		60
12		TX ON/OFF	TXLANE1-		59
13		RESERVED	TXLANE1+		58
14		MOD_DET	GND		57
15		VEND SPECIFIC	TXLANE0-		56
16		VEND SPECIFIC	TXLANE0+		55
17		MDIO	GND		54
18		MDC	GND		53
19		PRTAD4	GND		52
20		PRTAD3	RXLANE3-		51
21		PRTAD2	RXLANE3+		50
22		PRTAD1	GND		49
23		PRTAD0	RXLANE2-		48
24		VEND SPECIFIC	RXLANE2+		47
25		APS SET	GND		46
26		RESERVED	RXLANE1-		45
27		APS SENSE	RXLANE1+		44
28		APS	GND		43
29		APS	RXLANE0-		42
30		3.3V	RXLANE0+		41
31		3.3V	GND		40
32		5.0V (NOT USED)	RESERVED		39
33		GND	RESERVED		38
34		GND	GND		37
35		GND	GND		36

9. Pin Descriptions

Pin No	Name	Dir	Function	Notes
1	GND		Electrical Ground	1
2	GND		Electrical Ground	1
3	GND		Electrical Ground	1
4	5.0V		Power	2
5	3.3V		Power	2
6	3.3V		Power	2
7	APS =1.2V		Adaptive Power Supply	2
8	APS =1.2V		Adaptive Power Supply	2
9	LASI		Open Drain Compatible 10K-22K pull up on host. Logic High: Normal Operation Logic Low: LASI Asserted	3
10	RESET	I	Open Drain compatible. 10-22K pull-up on transceiver Logic high = Normal operation Logic low = Reset Minimum reset assert time 1 ms	3
11	VEND SPECIFIC		Vendor Specific Pin. Leave unconnected when not in use.	7
12	TX ON/OFF	I	Open Drain compatible. 10-22K pull-up on transceiver Logic high = Transmitter On (capable) Logic low = Transmitter Off (always)	3
13	RESERVED		Reserved	3
14	MOD DETECT	O	Pulled low inside module through 1k	
15	VEND SPECIFIC		Vendor Specific Pin. Leave unconnected when not in use.	7
16	VEND SPECIFIC		Vendor Specific Pin. Leave unconnected when not in use.	7
17	MDIO	I/O	Management Data IO	3, 4
18	MDC	I	Management Data Clock	3, 4
19	PRTAD4	I	Port Address Bit 4 (Low = 0)	3
20	PRTAD3	I	Port Address Bit 3 (Low = 0)	3
21	PRTAD2	I	Port Address Bit 2 (Low = 0)	3
22	PRTAD1	I	Port Address Bit 1	3
23	PRTAD0	I	Port Address Bit 0 (Low = 0)	3
24	VEND SPECIFIC		Vendor Specific Pin. Leave unconnected when not in use.	7
25	APS SET		Feedback input for APS	
26	RESERVED		Reserved for Avalanche Photodiode use.	7
27	APS SENSE		APS Sense Connection	

XENPAK-CWDM-1410-80-A10GBASE, CWDM, XENPAK, ZR, (SM)
1470 NM - 1610 NM, 80 KM REACH, SC

Pin No	Name	Dir	Function	Notes
28	APS =1.2V		Adaptive Power Supply	2
29	APS =1.2V		Adaptive Power Supply	2
30	3.3V		Power	2
31	3.3V		Power	2
32	5.0V		Power	2
33	GND		Electrical Ground	1
34	GND		Electrical Ground	1
35	GND		Electrical Ground	1
36	GND		Electrical Ground	1
37	GND		Electrical Ground	1
38	RESERVED		Reserved	
39	RESERVED		Reserved	
40	GND		Electrical Ground	1
41	RX LANE0+	O	Module XAUI Output Lane 0+	5
42	RX LANE0-	O	Module XAUI Output Lane 0-	5
43	GND		Electrical Ground	1
44	RX LANE1+	O	Module XAUI Output Lane 1+	5
45	RX LANE1-	O	Module XAUI Output Lane 1-	5
46	GND		Electrical Ground	1
47	RX LANE2+	O	Module XAUI Output Lane 2+	5
48	RX LANE2-	O	Module XAUI Output Lane 2-	5
49	GND		Electrical Ground	1
50	RX LANE3+	O	Module XAUI Output Lane 3+	5
51	RX LANE3-	O	Module XAUI Output Lane 3-	5
52	GND		Electrical Ground	1
53	GND		Electrical Ground	1
54	GND		Electrical Ground	1
55	TX LANE0+	I	Module XAUI Input Lane 0+	5
56	TX LANE0-	I	Module XAUI Input Lane 0-	5
57	GND		Electrical Ground	1
58	TX LANE1+	I	Module XAUI Input Lane 1+	5
59	TX LANE1-	I	Module XAUI Input Lane 1-	5
60	GND		Electrical Ground	1
61	TX LANE2+	I	Module XAUI Input Lane 2+	5
62	TX LANE2-	I	Module XAUI Input Lane 2-	5
63	GND		Electrical Ground	1
64	TX LANE3+	I	Module XAUI Input Lane 3+	5

Pin No	Name	Dir	Function	Notes
65	TX LANE3-	I	Module XAUI Input Lane 3-	5
66	GND		Electrical Ground	1
67	RESERVED		Reserved	
68	RESERVED		Reserved	
69	GND		Electrical Ground	1
70	GND		Electrical Ground	1

Notes:

1. Ground connections are common for TX and RX.
2. All connector contacts are rated at 0.5A nominal.
3. 1.2V CMOS compatible.
4. MDIO and MDC timing must comply with IEEE802.3ae, Clause 45.3
5. XAUI output characteristics should comply with IEEE802.3ae Clause 47.
6. Transceivers will be MSA compliant when no signals are present on the vendor specific pins.

10. Block Diagram of Adapter Power Supply Circuit

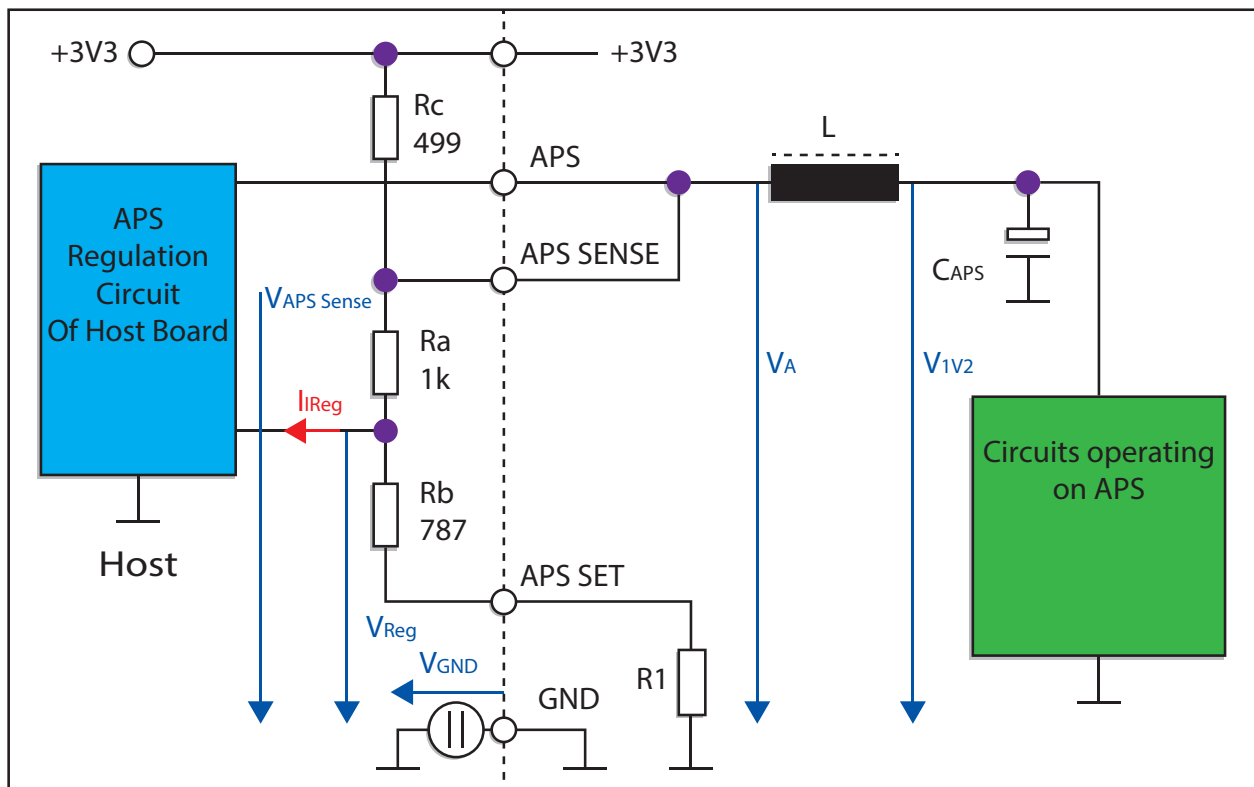

XENPAK-CWDM-1410-80-A

10GBASE, CWDM, XENPAK, ZR, (SM)
1470 NM - 1610 NM, 80 KM REACH, SC

11. Eye Safety

This laser based multimode transceiver is a Class 1 product. It complies with IEC 60825-1 Ed.2: 2007 and FDA performance standards for laser products (21 CFR 1040.10 and 1040.11) except for deviations pursuant to Laser Notice 50, dated June 24, 2007.

12. Package Outline

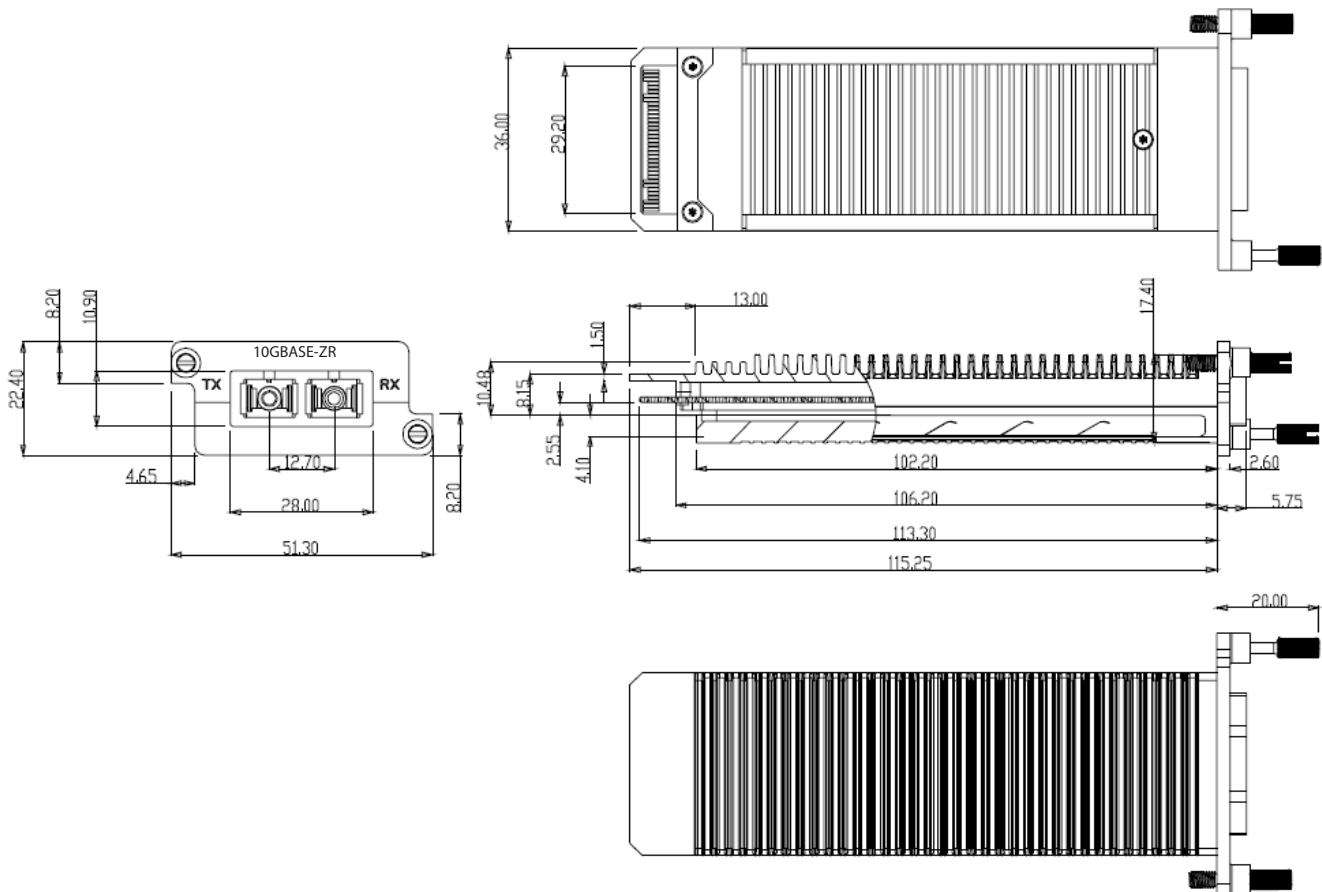

13. Contact Information

Approved Networks is a leading supplier of Network Transceivers and Connectivity products to Channel Partners, Resellers, and OEMs. With more than 9 years of direct industry experience, our products are resident in the most demanding and mission critical functional networks Worldwide. We serve as a Master Distributor to the largest CMs in the world and deploy the most rigorous testing and firmware management programs to bring the highest level of functional product to the market at a cost that makes sense.

Corporate Offices: **Approved Networks, Inc.**

Tel: 800.590.9535

Web: <http://www.approvednetworks.com>