

**XCVR-S10V31-23-10-A**  
10GBASE, SFP+, LR, BIDI Transceiver



## Features

- Supports up to 10.7Gbps bit rates
- Hot-pluggable SFP+ footprint
- 1270nm DFB laser and PIN photodiode, Up to 10km for SMF transmission
- Compliant with SFP+ MSA and SFF-8472with duplex LC receptacle
- Compatible with RoHS
- Single +3.3V power supply
- Real Time Digital Diagnostic Monitoring
- Commercial case operating temperature range: 0°C to +70°C

## 1. Description

The SFP+ transceivers are high performance, cost effective modules supporting data rate of 10Gbps and 10km transmission distance with SMF. The transceiver consists of three sections: a DFB laser transmitter, a PIN photodiode integrated with a trans-impedance preamplifier (TIA) and MCU control unit. All modules satisfy class I laser safety requirements. The transceivers are compatible with SFP Multi-Source Agreement and SFF-8472 digital diagnostics functions.

## Applications

- 10Gbps Optical systems
- 10GBASE-LR at 10.3125Gbps
- 10GBASE-LW at 9.953Gbps
- LTE systems
- Other Optical links



Figure 1. Transceiver functional diagram

## 2. Absolute Maximum Ratings

Any stress beyond the maximum ratings can result in permanent damage. The device specifications are guaranteed only under the recommended operating conditions.

Parameter	Symbol	Min	Max	Unit
Supply Voltage	Vcc	-0.5	4.5	V
Storage Temperature	Ts	-40	+85	°C
Operating Humidity	-	5	85	%

## 3. Recommended Operating Conditions

Parameter	Symbol	Min	Typ	Max	Unit
Operating Case Temperature	Tc	0		+70	°C
Power Supply Voltage @3.3V	Vcc	3.135	3.30	3.465	V
Power Supply Current	Icc			350	mA
Data Rate	1.0	10.3	10.7		Gbps

#### 4. Optical and Electrical Characteristics

Transmitter						
Parameter	Symbol	Min	Typ	Max	Unit	Notes
Centre Wavelength	$\lambda_c$	1260	1270	1280	nm	
Spectral Width (-20dB)	$\Delta\lambda$			1	nm	
Side-Mode Suppression Ratio	SMSR	30			dB	
Average Output Power	Pout	-5		0	dBm	1
Extinction Ratio	ER	3.5			dB	
Data Input Swing Differential	VIN	180		850	mV	2
Input Differential Impedance	ZIN	90	100	110	$\Omega$	
TX Disable	Disable		2.0		Vcc	V
	Enable		0		0.8	V
TX Fault	Fault		2.0		Vcc	
	Normal		0		0.8	
Receiver						
Parameter	Symbol	Min	Typ	Max	Unit	Notes
Centre Wavelength	$\lambda_c$	1230	1330	1340	nm	
Receiver Sensitivity				-14.4	dBm	3
Receiver Overload		0.5			dBm	3
LOS De-Assert	LOSD			-15.5	dBm	
LOS Assert	LOSA	-30			dBm	
LOS Hysteresis		0.5			dB	
Data Output Swing Differential	Vout	300		900	mV	4
LOS	High	2.0		Vcc	V	
	Low			0.8	V	

**Notes:**

1. The optical power is launched into SMF.
2. PECL input, internally AC-coupled and terminated.
3. Measured with a PRBS 2<sup>31</sup>-1 test pattern @10312 Mbps, BER  $\leq 1 \times 10^{-12}$ .
4. Internally AC-coupled.

## 5. Timing and Electrical

Parameter	Symbol	Min	Typ	Max	Unit
Tx Disable Negate Time	t_on			1	ms
Tx Disable Assert Time	t_off			10	μs
Time To Initialize, including Reset of Tx Fault	t_init			300	ms
Tx Fault Assert Time	t_fault			100	μs
Tx Disable To Reset	t_reset	10			μs
LOS Assert Time	t_loss_on			100	μs
LOS De-assert Time	t_loss_off			100	μs
Serial ID Clock Rate	f_serial_clock		100	400	KHz
MOD_DEF (0:2)-High	VH	2			V <sub>cc</sub>
MOD_DEF (0:2)-Low	VL			0.8	V

## 6. Diagnostics

Parameter	Range	Unit	Accuracy	Calibration
Temperature	0 to +70	°C	±3°C	Internal
	-20 to +80			
	-40 to +85			
Voltage	3.0 to 3.6	V	±3%	Internal
Bias Current	0 to 100	mA	±10%	Internal
TX Power	-1 to +5	dBm	±3dB	Internal
RX Power	-17 to +1	dBm	±3dB	Internal

## 7. Digital Diagnostic Memory Map

The transceivers provide serial ID memory contents and diagnostic information about the present operating conditions by the 2-wire serial interface (SCL, SDA).

The diagnostic information with internal calibration or external calibration all are implemented, including received power monitoring, transmitted power monitoring, bias current monitoring, supply voltage monitoring and temperature monitoring.

The digital diagnostic memory map specific data field defines as following.



**8. Pin Descriptions**

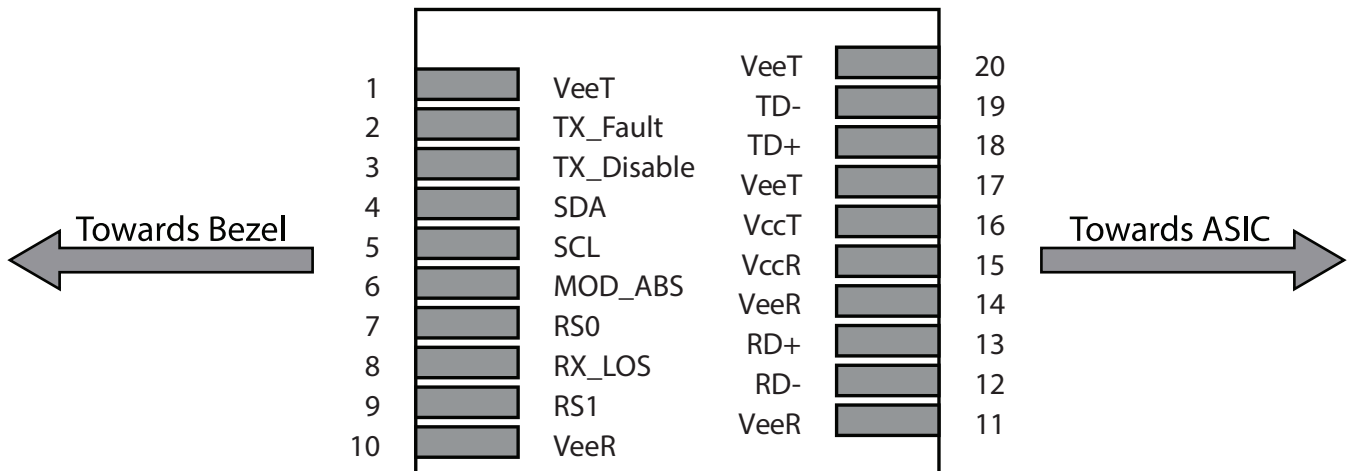

Pin	Signal Name	Description	Plug Seq.	Notes
1	VEET	Transmitter Ground	1	
2	TX FAULT	Transmitter Fault Indication	3	1
3	TX DISABLE	Transmitter Disable	3	2
4	SDA	SDA Serial Data Signal	3	
5	SCL	SCL Serial Clock Signal	3	
6	MOD_ABS	Module Absent. Grounded within the module	3	
7	RS0	Not Connected	3	
8	LOS	Loss of Signal	3	3

Pin	Signal Name	Description	Plug Seq.	Notes
9	RS1	Not Connected	3	
10	VEER	Receiver ground	1	
11	VEER	Receiver ground	1	
12	RD- Inv.	Received Data Out	3	4
13	RD+	Received Data Out	3	4
14	VEER	Receiver ground	1	
15	VCCR	Receiver Power Supply	2	
16	VCCT	Transmitter Power Supply	2	
17	VEET	Transmitter Ground	1	
18	TD+	Transmit Data In	3	5
19	TD-	Inv. Transmit Data In	3	5
20	VEET	Transmitter Ground	1	

**Notes:**

Plug Seq: Pin engagement sequence during hot plugging.

1. TX Fault is an open collector output, which should be pulled up with a 4.7k~10kΩ resistor on the host board to a voltage between 2.0V and Vcc+0.3V. Logic 0 indicates normal operation; Logic 1 indicates a laser fault of some kind. In the low state, the output will be pulled to less than 0.8V.
2. Laser output disabled on TDIS >2.0V or open, enabled on TDIS <0.8V.
3. LOS is open collector output. Should be pulled up with 4.7k~10kΩ on host board to a voltage between 2.0V and 3.6V. Logic 0 indicates normal operation; logic 1 indicates loss of signal.
4. RD-/+: These are the differential receiver outputs. They are internally AC-coupled 100 differential lines which should be terminated with 100Ω (differential) at the user SERDES.
5. TD-/+: These are the differential transmitter inputs. They are internally AC-coupled, differential lines with 100Ω differential termination inside the module.

**9. Recommended Interface Circuit**

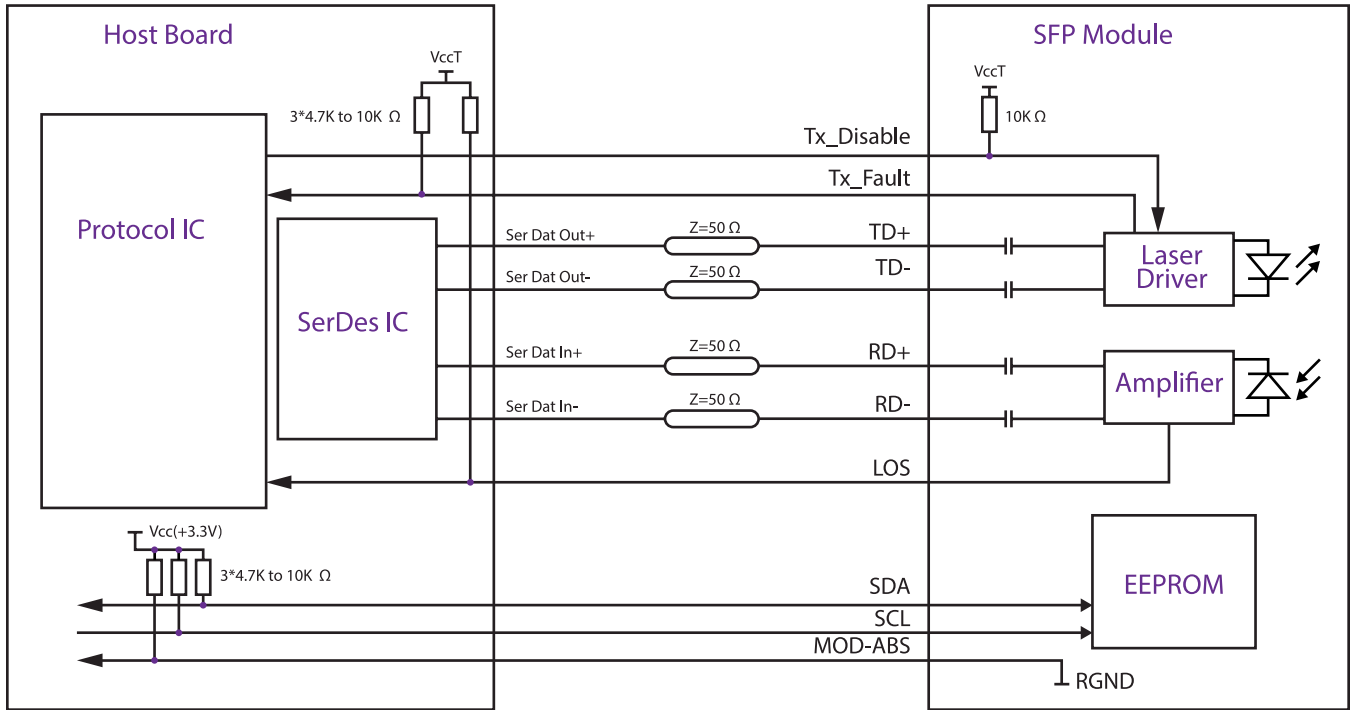

**10. Mechanical Dimintions**



## 11. Contact Information

Approved Networks is a leading supplier of Network Transceivers and Connectivity products to Channel Partners, Resellers, and OEMs. With more than 9 years of direct industry experience, our products are resident in the most demanding and mission critical functional networks Worldwide. We serve as a Master Distributor to the largest CMs in the world and deploy the most rigorous testing and firmware management programs to bring the highest level of functional product to the market at a cost that makes sense.

Corporate Offices: **Approved Networks, Inc.**

Tel: 800.590.9535

Web: <http://www.approvednetworks.com>