

JSH-01DWAA1-057-A
10GBASE, SFP+, DWDM, ZR Transceiver

Features

- Up to 11.3Gbps Data Links
- Up to 80km transmission on SMF
- DWDM EML Laser and APD receiver
- Metal enclosure, for lower EMI
- 2-wire interface with integrated Digital Diagnostic monitoring
- Hot-pluggable SFP+ footprint
- Specifications compliant with SFF 8472
- Compliant with SFP+ MSA with LC connector
- Single 3.3V power supply
- Case operating temperature range: 0°C to 70°C
- Power dissipation < 1.5Wp

1. Description

Approved Networks' SFP+-DWDM-ZR optical transceivers are Enhanced Small Form Factor Pluggable SFP+ transceivers designed for use in 10-Gigabit multi-rate links up to 80km of G.652 single mode fiber. They are compliant with SFF-8431, SFF-8432, and G.698.1 DS100S1-2Dz(C), and 10G Ethernet ZR and 10G Fibre Channel over 80km fiber. Digital diagnostics functions are available via a 2-wire serial interface, as specified in SFF-8472. The optical transceiver is compliant per the RoHS Directive 2011/65/EU.



Applications

- 10G Ethernet
- 10G SONET/SDH, OTU2/2e and 10G FC

Standard

- Compliant to SFF-8431
- RoHS Compliant.

C-band λ c Wavelength Guide Pin Descriptions

| Channel | Wavelength (nm) | Frequency (THZ) | Channel | Wavelength (nm) | Frequency (THZ) |
|---------|---|-----------------|---------|-----------------|-----------------|
| C17 | 1563.86 | 191.70 | C39 | 1546.12 | 193.90 |
| C18 | 1563.05 | 191.80 | C40 | 1545.32 | 194.00 |
| C19 | 1562.23 | 191.90 | C41 | 1544.53 | 194.10 |
| C20 | 1561.42 | 192.00 | C42 | 1543.73 | 194.20 |
| C21 | 1560.61 | 192.10 | C43 | 1542.94 | 194.30 |
| C22 | 1559.79 | 192.20 | C44 | 1542.14 | 194.40 |
| C23 | 1558.98 | 192.30 | C45 | 1541.35 | 194.50 |
| C24 | 1558.17 | 192.40 | C46 | 1540.56 | 194.60 |
| C25 | 1557.36 | 192.50 | C47 | 1539.77 | 194.70 |
| C26 | 1556.55 | 192.60 | C48 | 1538.98 | 194.80 |
| C27 | 1555.75 | 192.70 | C49 | 1538.19 | 194.90 |
| C28 | 1554.94 | 192.80 | C50 | 1537.40 | 195.00 |
| C29 | 1554.13 | 192.90 | C51 | 1536.61 | 195.10 |
| C30 | 1553.33 | 193.00 | C52 | 1535.82 | 195.20 |
| C31 | 1552.52 | 193.10 | C53 | 1535.04 | 195.30 |
| C32 | 1551.72 | 193.20 | C54 | 1534.25 | 195.40 |
| C33 | 1550.92 | 193.30 | C55 | 1533.47 | 195.50 |
| C34 | 1550.12 | 193.40 | C56 | 1532.68 | 195.60 |
| C35 | 1549.32 | 193.50 | C57 | 1531.90 | 195.70 |
| C36 | 1548.51 | 193.60 | C58 | 1531.12 | 195.80 |
| C37 | 1547.72 | 193.70 | C59 | 1530.33 | 195.90 |
| C38 | 1546.92 | 193.80 | C60 | 1529.55 | 196.00 |
| Non-ITU | Peak wavelength between 1528.77nm-1563.86 | | C61 | 1528.77 | 196.10 |

2. Absolute Maximum Ratings

Any stress beyond the maximum ratings can result in permanent damage. The device specifications are guaranteed only under the recommended operating conditions.

| Parameter | Symbol | Min | Typ | Max | Unit |
|----------------------|--------|---------|-----|---------|------|
| Storage Temperature | Ts | -40 | - | 85 | °C |
| Relative Humidity | RH | 5 | - | 95 | % |
| Power Supply Voltage | VCC | -0.3 | - | 4 | V |
| Signal Input Voltage | | Vcc-0.3 | - | Vcc+0.3 | V |

3. Recommended Operating Conditions

| Parameter | Symbol | Min | Typ | Max | Unit | Notes |
|----------------------------|-------------------|------|---------|------|------|-------------|
| Case Operating Temperature | Tcase | 0 | - | 70 | °C | Commercial |
| Power Supply Voltage | VCC | 3.14 | 3.3 | 3.47 | V | |
| Power Supply Current | ICC | - | | 450 | mA | |
| Data Rate | BR | | 10.3125 | | Gbps | |
| Transmission Distance | TD | | - | 80 | Km | |
| Coupled fiber | Single mode fiber | | | | | 9/125um SMF |

4. Optical Characteristics

| Transmitter | | | | | | |
|------------------------------------|-----------------------------|-----------------|-----|-----------------|------|------|
| Parameter | Symbol | Min | Typ | Max | Unit | Note |
| Average Optical Power | Pout | -1 | | 4 | dBm | 1 |
| Center Wavelength Spacing | | | 100 | | GHz | 2 |
| Optical Wavelength | λ_c | $\lambda_c-0.1$ | | $\lambda_c+0.1$ | nm | |
| Optical Extinction Ratio | ER | 6.0 | | | dB | |
| Side Mode Supression Ratio | SMSR | 30 | | | dB | |
| Average Launch Power | Poff | | | -30 | dBm | |
| Transmitter and Dispersion Penalty | TDP | | | 3.0 | dB | |
| Output Eye Mask | Compliant with IEEE 802.3ae | | | | | |
| Receiver | | | | | | |
| Parameter | Symbol | Min | Typ | Max | Unit | Note |
| Wavelength Range | λ_c | 1480 | | 1580 | nm | |
| Receiver Sensitivity | Rsen | | | -23 | dBm | 3 |
| Input Saturation Power (Overload) | Psat | -6 | | | dBm | |
| LOS Assert | LOSA | -35 | | | dBm | |
| LOS De-assert | LOSD | | | -26 | dBm | |
| LOS Detect Hysteresis | PHYS | 0.5 | | | dB | |

Notes:

1. Output power is power coupled into a 9/125 mm single-mode fiber.
2. Corresponds to approximately 0.8 nm.
3. Measured with a PRBS 2³¹-1 test pattern, @10.325Gb/s, BER<10⁻¹².

5. Electrical Characteristics

| Parameter | Symbol | Min | Typ | Max | Unit | Notes |
|--------------------------------|------------|---------|-----|----------|----------|-------|
| Supply Voltage | Vcc | 3.14 | 3.3 | 3.46 | V | |
| Supply Current | Icc | | | 450 | mA | |
| Transmitter | | | | | | |
| Parameter | Symbol | Min | Typ | Max | Unit | Notes |
| Input differential impedance | ohm | | 100 | | Ω | 1 |
| Single ended data input swing | Vin,pp | 120 | | 820 | mV | |
| Transmit Disable Voltage | VD | Vcc-1.3 | | Vcc | V | |
| Transmit Enable Voltage | VEN | Vee | | Vee+ 0.8 | V | 2 |
| TX_FAULT Voltage-High | | Vcc-1.3 | | Vcc | | |
| TX_FAULT Voltage-Low | | Vee | | Vee+ 0.8 | | |
| Transmit Disable Assert Time | | | | 10 | us | |
| Receiver | | | | | | |
| Parameter | Symbol | Min | Typ | Max | Unit | Notes |
| Differential data output swing | Vout,pp | 350 | | 850 | mV | 3 |
| Data output rise time | tr | 30 | | | ps | 4 |
| Data output fall time | tf | 30 | | | ps | 4 |
| LOS Fault | VLOS fault | Vcc-1.3 | | VccHOST | V | 5 |
| LOS Normal | VLOS norm | Vee | | Vee+0.8 | V | 5 |

Notes:

1. Connected directly to TX data input pins. AC coupled thereafter.
2. Or open circuit.
3. Into 100 ohms differential termination.
4. These are unfiltered 20-80% values
5. Loss Of Signal is LVTTTL. Logic 0 indicates normal operation; logic 1 indicates no signal detected.

6. Pin Description

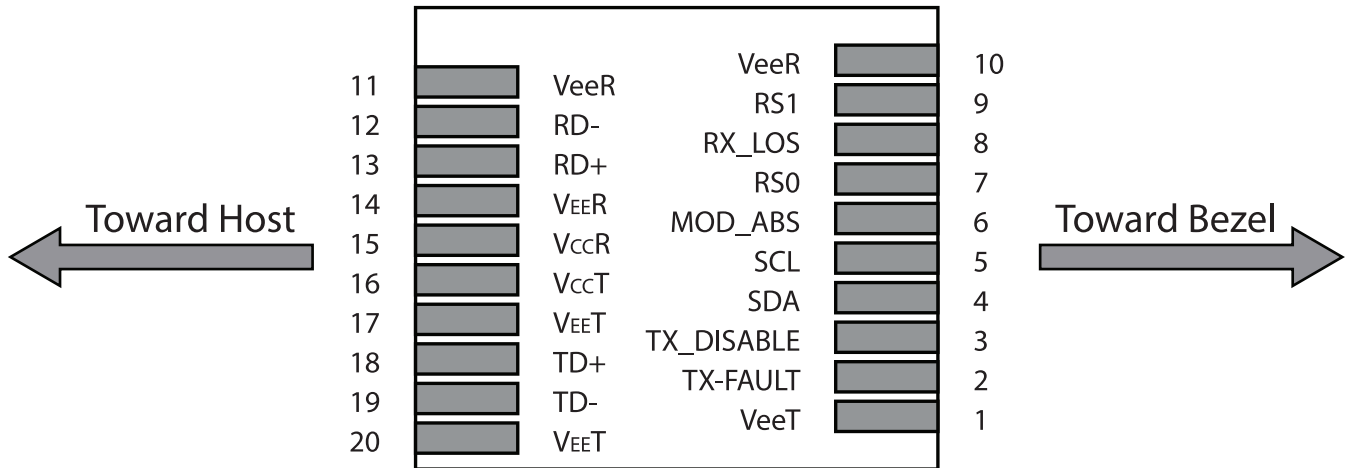

Figure 1. Pin out of Connector Block on Host Board

| Pin | Symbol | Name/Description | Notes |
|-----|---------|--|-------|
| 1 | VEET | Transmitter Ground (Common with Receiver Ground) | 1 |
| 2 | TFAULT | Transmitter Fault. | 2 |
| 3 | TDIS | Transmitter Disable. Laser output disabled on high or open. | 3 |
| 4 | SDA | 2-wire Serial Interface Data Line | 4 |
| 5 | SCL | 2-wire Serial Interface Clock Line | 4 |
| 6 | MOD_ABS | Module Absent. Grounded within the module | 4 |
| 7 | RS0 | Rate Select 0 | 5 |
| 8 | LOS | Loss of Signal indication. Logic 0 indicates normal operation. | 6 |
| 9 | RS1 | No connection required | 1 |
| 10 | VEER | Receiver Ground (Common with Transmitter Ground) | 1 |
| 11 | VEER | Receiver Ground (Common with Transmitter Ground) | 1 |
| 12 | RD- | Receiver Inverted DATA out. AC Coupled | |
| 13 | RD+ | Receiver Non-inverted DATA out. AC Coupled | |
| 14 | VEER | Receiver Ground (Common with Transmitter Ground) | 1 |
| 15 | VCCR | Receiver Power Supply | |
| 16 | VCCT | Transmitter Power Supply | |
| 17 | VEET | Transmitter Ground (Common with Receiver Ground) | 1 |
| 18 | TD+ | Transmitter Non-Inverted DATA in. AC Coupled. | |
| 19 | TD- | Transmitter Inverted DATA in. AC Coupled. | |
| 20 | VEET | Transmitter Ground (Common with Receiver Ground) | 1 |

Notes:

1. Circuit ground is internally isolated from chassis ground.
2. TFAULT is an open collector/drain output, which should be pulled up with a 4.7k – 10k Ohms resistor on the host board if intended for use. Pull up voltage should be between 2.0V to Vcc + 0.3V. A high output indicates a transmitter fault caused by either the TX bias current or the TX output power exceeding the preset alarm thresholds. A low output indicates normal operation. In the low state, the output is pulled to <0.8V.
3. Laser output disabled on TDIS >2.0V or open, enabled on TDIS <0.8V.
4. Should be pulled up with 4.7kΩ- 10kΩ host board to a voltage between 2.0V and 3.6V. MOD_ABS pulls line low to indicate module is plugged in.
5. Internally pulled down per SFF-8431 Rev 4.1.
6. LOS is open collector output. It should be pulled up with 4.7kΩ – 10kΩ on host board to a voltage between 2.0V and 3.6V. Logic 0 indicates normal operation; logic 1 indicates loss of signal.

7. Digital Diagnostic Functions

This transceiver supports the 2-wire serial communication protocol as defined in the SFP+ MSA. The standard SFP serial ID provides access to identification information that describes the transceiver’s capabilities, standard interfaces, manufacturer, and other information.

Additionally, SFP+ transceivers provide a unique enhanced digital diagnostic monitoring interface, which allows real-time access to device operating parameters such as transceiver temperature, laser bias current, transmitted optical power, received optical power and transceiver supply voltage. It also defines a sophisticated system of alarm and warning flags, which alerts end-users when particular operating parameters are outside of a factory set normal range.

The SFP MSA defines a 256-byte memory map in EEPROM that is accessible over a 2-wire serial interface at the 8 bit address 1010000X (A0h). The digital diagnostic monitoring interface makes use of the 8 bit address 1010001X (A2h), so the originally defined serial ID memory map remains unchanged.

The operating and diagnostics information is monitored and reported by a Digital Diagnostics Transceiver Controller (DDTC) inside the transceiver, which is accessed through a 2-wire serial interface. When the serial protocol is activated, the serial clock signal (SCL, Mod Def 1) is generated by the host. The positive edge clocks data into the SFP transceiver into those segments of the EEPROM that are not write-protected. The negative edge clocks data from the SFP transceiver. The serial data signal (SDA, Mod Def 2) is bi-directional for serial data transfer. The host uses SDA in conjunction with SCL to mark the start and end of serial protocol activation. The memories are organized as a series of 8-bit data words that can be addressed individually or sequentially.

8. Recommended Interface Circuit

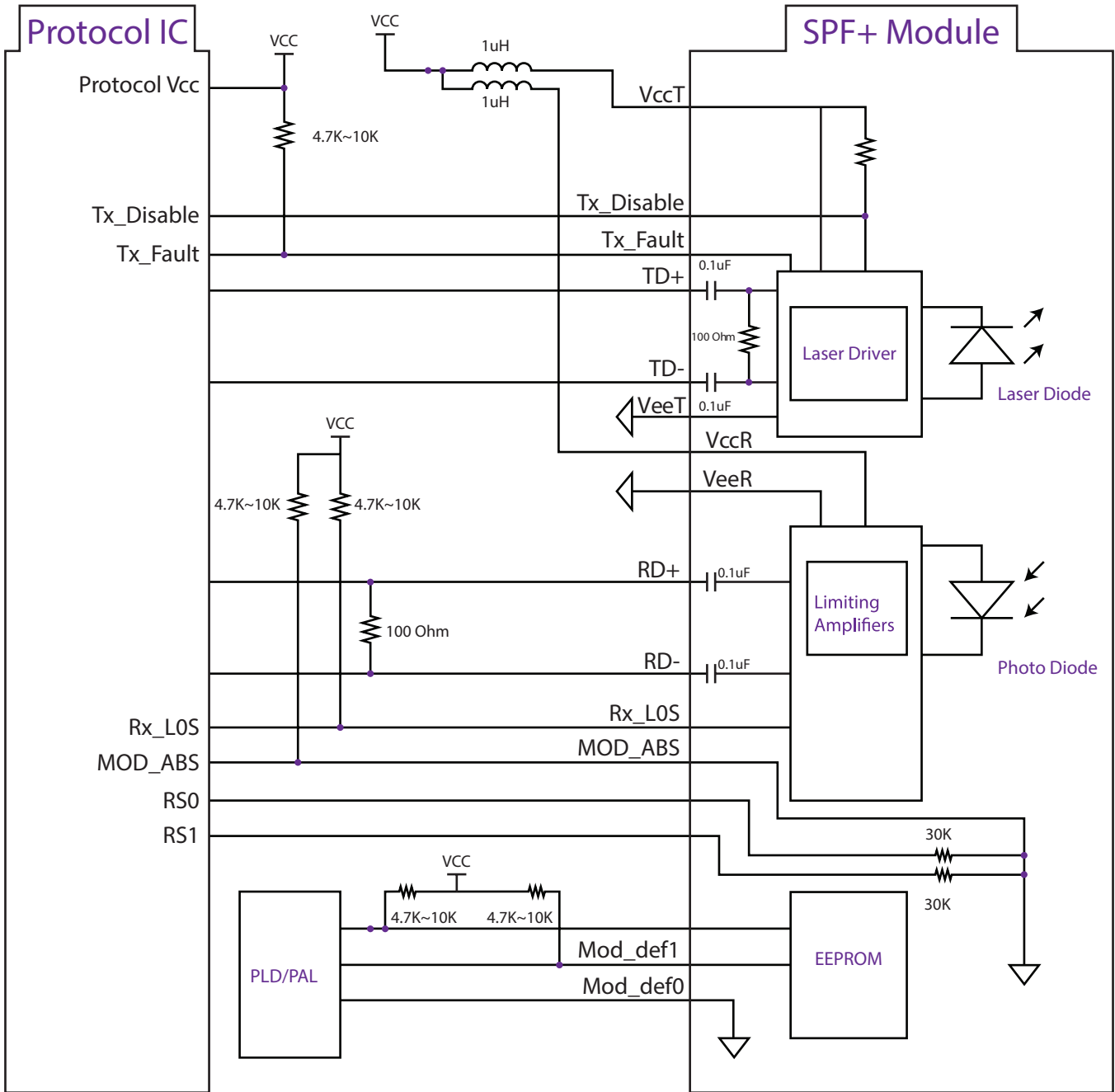

9. Outline Dimentions

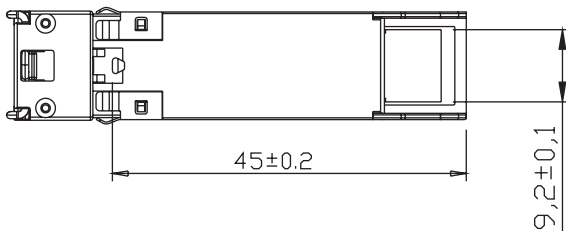
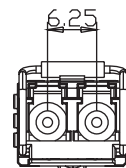
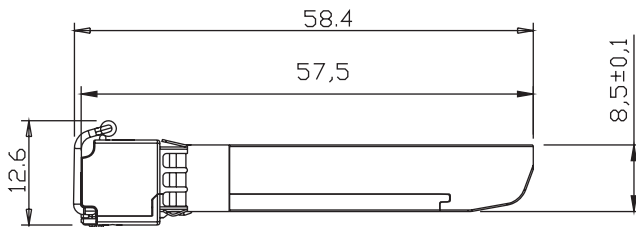
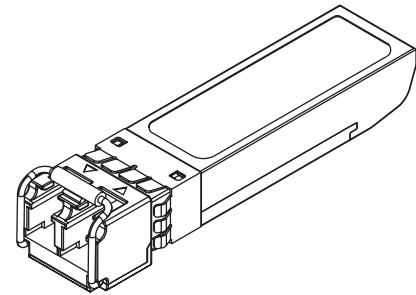
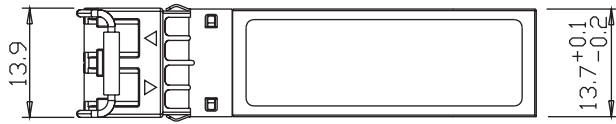

Units in MM

10. Regulatory Compliance

| Feature | Reference | Performance |
|------------------------------------|---|---------------------------|
| Electrostatic discharge (ESD) | IEC/EN 61000-4-2 | Compatible with standards |
| Electromagnetic Interference (EMI) | FCC Part 15 Class B EN 55022 Class B (CISPR 22A) | Compatible with standards |
| Laser Eye Safety | FDA 21CFR 1040.10, 1040.11 IEC/EN 60825-1, 2 | Class 1 laser product |
| Component Recognition | IEC/EN 60950, UL | Compatible with standards |
| ROHS | 2002/95/EC | Compatible with standards |
| EMC | EN61000-3 | Compatible with standards |

11. Contact Information

Approved Networks is a leading supplier of Network Transceivers and Connectivity products to Channel Partners, Resellers, and OEMs. With more than 9 years of direct industry experience, our products are resident in the most demanding and mission critical functional networks Worldwide. We serve as a Master Distributor to the largest CMs in the world and deploy the most rigorous testing and firmware management programs to bring the highest level of functional product to the market at a cost that makes sense.

Corporate Offices: **Approved Networks, Inc.**

Tel: 800.590.9535

Web: <http://www.approvednetworks.com>