

DWDM-SFP-1541.35-J-A

MULTIRATE, DWDM, SFP, ZX, (SM)
1528 - 1563 NM, 80 KM REACH, LC

DWDM-SFP-1541.35-J-A

MULTIRATE, DWDM, SFP, ZX Transceiver

Features

- Transceiver unit with independent DWDM DFB Laser diode transmitter & APD photodiode receiver
- Compliant with DWDM SFP MSA
- SFF-8472 with duplex LC receptacle
- Hot-pluggable
- Metal enclosure for lower EMI
- 3.3V Single power supply
- 100GHz ITU Grid, C Band
- Wavelength controlled within ± 0.1 nm over life and temperature
- Digital diagnostic monitoring
- 80 km with 9/125 μ m single mode fiber (SMF) of maximum interconnect distances
- Commercial case operating temperature: 0°C to +70°C



Applications

- C Band DWDM networks
- SONET/SDH networks
- Fiber channel
- Gigabit Ethernet

1. Description

Approved Networks SFP DWDM ZX Small Form Factor Pluggable (SFP) transceivers are compatible with the Small Form Factor Pluggable Multi-Sourcing Agreement (MSA) and SFF-8472. The transceiver consists of five sections: the LD driver, the limiting amplifier, the digital diagnostic monitor, the DFB laser and the APD. The module data link up to 80KM in 9/125um single mode fiber. It offers a simple and convenient way to interface PCBs to single mode fiber optic cables in Dense Wavelength Division Multiplexing (DWDM) applications. It is a high performance, cost effective module for serial optical data communication applications.

The optical output can be disabled by a TTL logic high-level input of Tx Disable, and the system also can disable the module via I2C. Tx Fault is provided to indicate that degradation of the laser. Loss of signal (LOS) output is provided to indicate the loss of an input optical signal of receiver or the link status with partner. The system can also get the LOS (or Link)/Disable/Fault information via I2C register access.

2. Pin Descriptions



Figure 1. Pin out of Connector Block on Host Board

Pin	Symbol	Name/Description	Notes
1	VEET	Transmitter Ground (Common with Receiver Ground)	1
2	TFAULT	Transmitter Fault.	
3	TDIS	Transmitter Disable. Laser output disabled on high or open.	2
4	MOD_DEF(2)	Module Definition 2. Data line for Serial ID.	3
5	MOD_DEF(1)	Module Definition 1. Clock line for Serial ID.	3
6	MOD_DEF(0)	Module Definition 0. Grounded within the module.	3
7	Rate Select	No connection required	4
8	LOS	Loss of Signal indication. Logic 0 indicates normal operation.	5
9	VEER	Receiver Ground (Common with Transmitter Ground)	1
10	VEER	Receiver Ground (Common with Transmitter Ground)	1
11	VEER	Receiver Ground (Common with Transmitter Ground)	1
12	RD-	Receiver Inverted DATA out. AC Coupled	
13	RD+	Receiver Non-inverted DATA out. AC Coupled	
14	VEER	Receiver Ground (Common with Transmitter Ground)	1
15	VCCR	Receiver Power Supply	
16	VCCT	Transmitter Power Supply	
17	VEET	Transmitter Ground (Common with Receiver Ground)	1
18	TD+	Transmitter Non-Inverted DATA in. AC Coupled.	
19	TD-	Transmitter Inverted DATA in. AC Coupled.	
20	VEET	Transmitter Ground (Common with Receiver Ground)	1

Notes:

1. Circuit ground is internally isolated from chassis ground.
2. Laser output disabled on TDIS >2.0V or open, enabled on TDIS <0.8V.
3. Should be pulled up with 4.7k - 10kohms on host board to a voltage between 2.0V and 3.6V MOD_DEF (0) pulls line low to indicate module is plugged in.
4. This is an optional input used to control the receiver bandwidth for compatibility with multiple data rates (most likely Fiber Channel 1x and 2x Rates).If implemented, the input will be internally pulled down with > 30kΩ resistor. The input states are:
 - Low (0 – 0.8V): Reduced Bandwidth
 - (>0.8, < 2.0V): Undefined
 - High (2.0 – 3.465V): Full Bandwidth
 - Open: Reduced Bandwidth
5. LOS is open collector output should be pulled up with 4.7k - 10kohms on host board to a voltage between 2.0V and 3.6V. Logic 0 indicates normal operation; logic 1 indicates loss of signal.

3. Absolute Maximum Ratings

Parameter	Symbol	Min.	Typ.	Max.	Unit
Storage Temperature	Ts	-40		85	°C
Relative Humidity	RH	5		95	%
Power Supply Voltage	VCC	-0.5		4	V
Signal Input Voltage		-0.3		Vcc+0.3	V
Receiver Damage Threshold		+5			dBm

4. Recommended Operating Conditions

Parameter	Symbol	Min.	Typ.	Max.	Unit	Notes
Case Operating Temperature	Tcase	0		70	°C	
Power Supply Voltage	VCC	3.13	3.3	3.47	V	
Power Supply Current	ICC			500	mA	
Power Supply Noise Rejection				100	mVp-p	100Hz to 1MHz
Data Rate			1250/1250		Mbps	TX Rate/RX Rate
Transmission Distance				80	KM	
Coupled Fiber	Single mode fiber					9/125um SMF

5. Specification of Transmitter

Parameter	Symbol	Min.	Typ.	Max.	Unit	Notes
Center Wavelength Spacing			100		GHz	
Center Wavelength	λ	X-100	X	X+100	pm	1
Average Output Power	POUT	0		4	dBm	
Extinction Ratio	ER	9			dB	
Side Mode Suppression Ratio	SMSR	30			dB	
Spectrum Bandwidth (-20dB)	σ			0.3	nm	
Transmitter OFF Output Power	POff			-45	dBm	
Differential Line Input Impedance	RIN	90	100	110	Ohm	
Output Eye Mask	Compliant with IEEE 802.3 Z					2

Notes:

1. X = specified ITU center wavelength.
2. Transmitter eye mask definition.

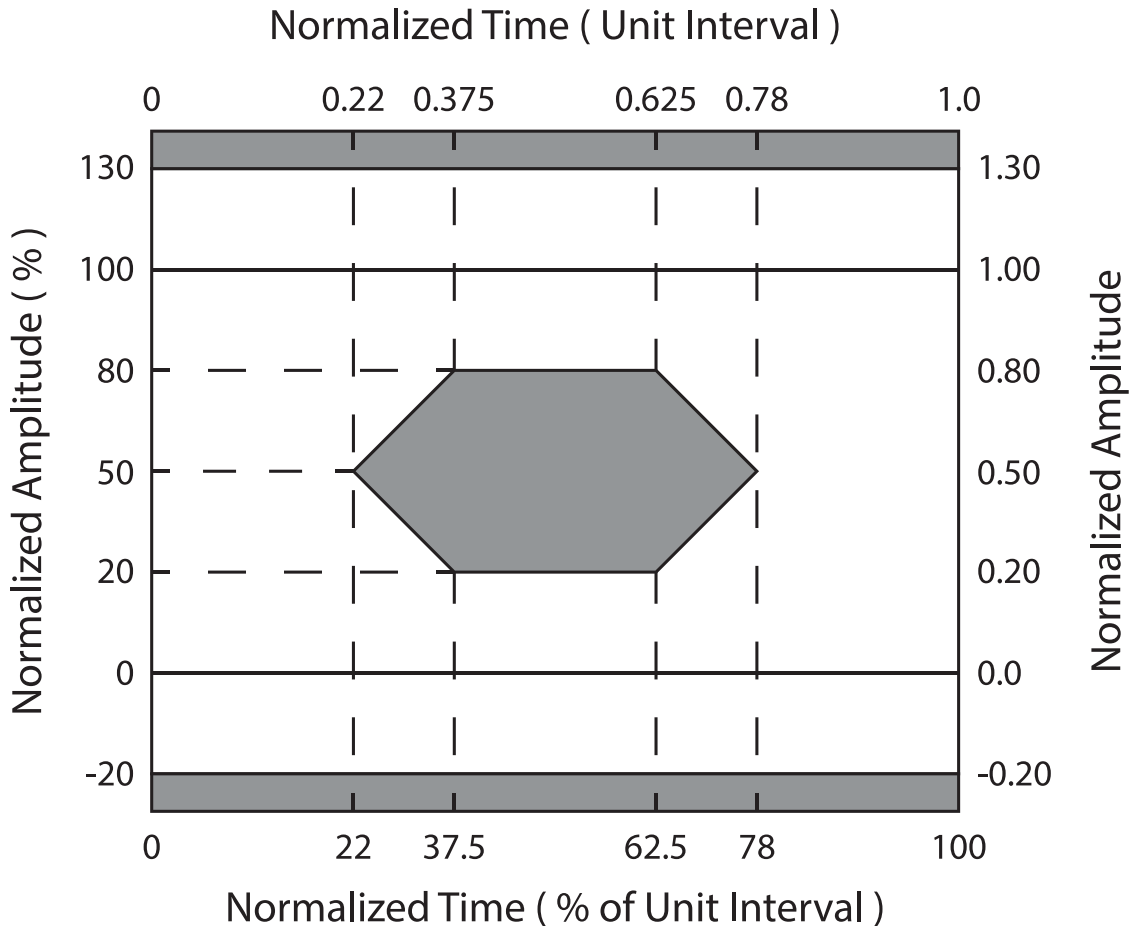

Figure 2. Transmitter Eye Mask

6. Specification of Receiver

Parameter	Symbol	Min.	Typ.	Max.	Unit	Notes
Input Optical Wavelength	λ_{IN}	1270		1610	nm	APD
Receiver Sensitivity	PIN			-26	dBm	1
Input Saturation Power (Overload)	PSAT	-3			dBm	
Los Of Signal Assert	PA			-26	dBm	
Los Of Signal De-assert	PD	-38			dBm	2
LOS Hysteresis	PA-PD	0.5	2	6	dB	

Notes:

1. Measured with Light source 1550nm, ER=9dB; BER = $<10^{-12}$ @PRBS=2²³-1 NRZ
2. When LOS de-asserted, the RX data+/- output is High-level (fixed)

7. Electrical Interface Characteristics

Transmitter						
Parameter	Symbol	Min.	Typ.	Max.	Unit	Notes
Total Supply Current	ICC			A	mA	1
Transmitter Disable Input-High	VDISH	2		V _{CC} +0.3	V	
Transmitter Disable Input-Low	VDISL	0		0.8	V	
Transmitter Fault Input-High	VTxFH	2		V _{CC} +0.3	V	
Transmitter Fault Input-Low	VTxFL	0		0.8	V	
Receiver						
Parameter	Symbol	Min.	Typ.	Max.	Unit	Notes
Total Supply Current	ICC			B	mA	1
LOSS Output Voltage-High	VLOSH	2		V _{CC} +0.3	V	LVTTTL
LOSS Output Voltage-Low	VLOSL	0		0.8	V	

Notes:

1. A (TX) + B (RX) = 500mA (Does not include termination circuit)

8. Digital Diagnostic Functions

Approved Networks SFP DWDM ZX transceivers support the 2-wire serial communication protocol as defined in the SFP MSA. It is very closely related to the E2PROM defined in the GBIC standard, with the same electrical specifications.

The standard SFP serial ID provides access to identification information that describes the transceiver’s capabilities, standard interfaces, manufacturer, and other information.

Additionally, Approved Networks SFP transceivers provide a unique enhanced digital diagnostic monitoring interface, which allows real-time access to device operating parameters such as transceiver temperature, laser bias current, transmitted optical power, received optical power and transceiver supply voltage. It also defines a sophisticated system of alarm and warning flags, which alerts end-users when particular operating parameters are outside of a factory set normal range.

The SFP MSA defines a 256-byte memory map in E2PROM that is accessible over a 2-wire serial interface at the 8 bit address 1010000X (A0h). The digital diagnostic monitoring interface makes use of the 8 bit address 1010001X (A2h), so the originally defined serial ID memory map remains unchanged. The interface is identical to, and is thus fully backward compatible with both the GBIC Specification and the SFP Multi Source Agreement.

The operating and diagnostics information is monitored and reported by a Digital Diagnostics Transceiver Controller (DDTC) inside the transceiver, which is accessed through a 2-wire serial interface. When the serial protocol is activated, the serial clock signal (SCL, Mod Def 1) is generated by the host. The positive edge clocks data into the SFP transceiver into those segments of the E2PROM that are not write-protected. The negative edge clocks data from the SFP transceiver. The serial data signal (SDA, Mod Def 2) is bi-directional for serial data transfer. The host uses SDA in conjunction with SCL to mark the start and end of serial protocol activation. The memories are organized as a series of 8-bit data words that can be addressed individually or sequentially. Digital diagnostics for the SFP DWDM ZX are internally calibrated by default.



Figure 3. Diagnostic Memory Map (Specific Data Field Descriptions)

9. Recommend Circuit Schematic



Figure 4. Recommended Host Circuit

DWDM-SFP-1541.35-J-A

MULTIRATE, DWDM, SFP, ZX, (SM)

1528 - 1563 NM, 80 KM REACH, LC

10. Mechanical Specifications

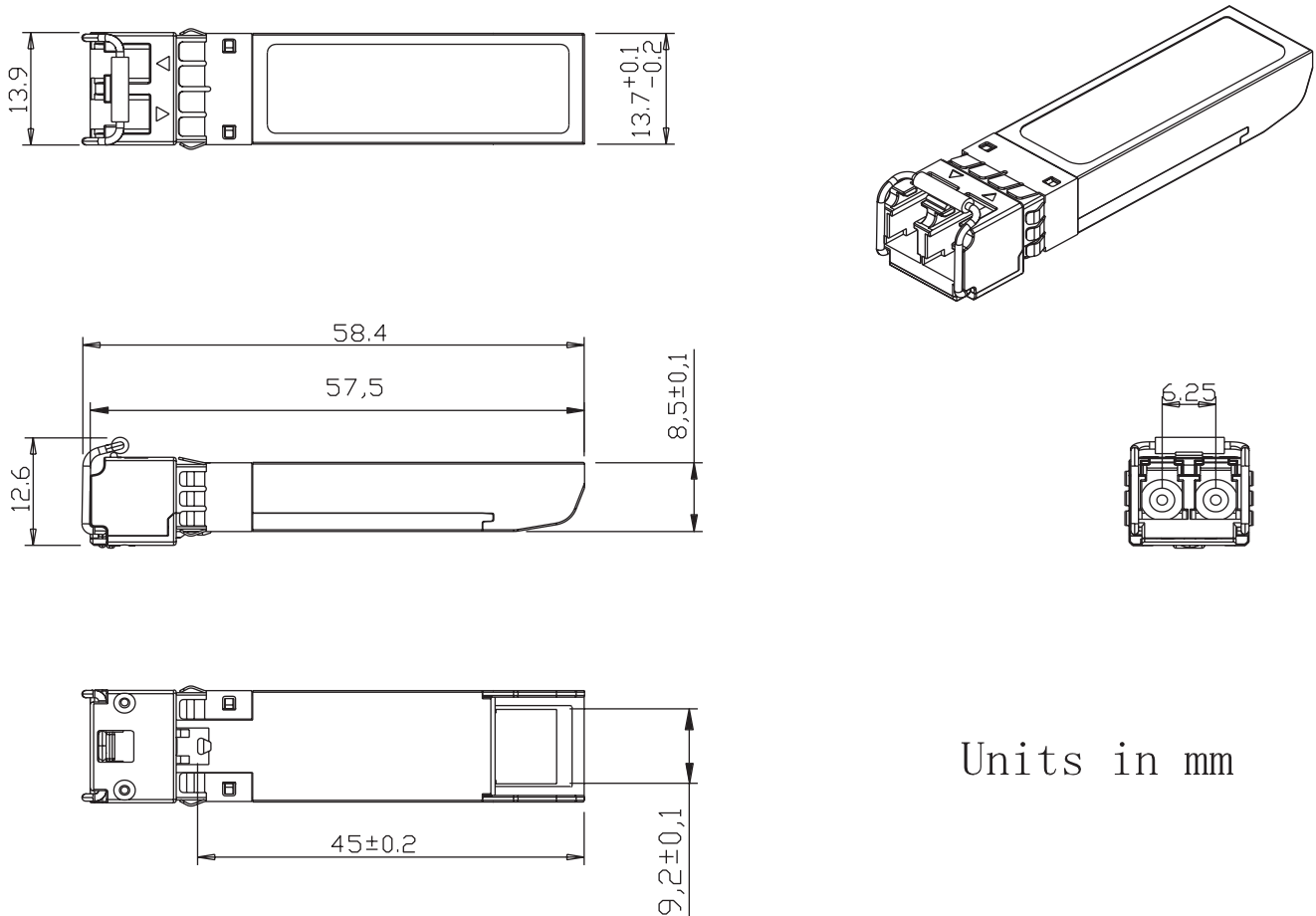

Figure 4. Mechanical Specifications

15. Contact Information

Approved Networks is a leading supplier of Network Transceivers and Connectivity products to Channel Partners, Resellers, and OEMs. With more than 9 years of direct industry experience, our products are resident in the most demanding and mission critical functional networks Worldwide. We serve as a Master Distributor to the largest CMs in the world and deploy the most rigorous testing and firmware management programs to bring the highest level of functional product to the market at a cost that makes sense.

Corporate Offices: **Approved Networks, Inc.**

Tel: 800.590.9535

Web: <http://www.approvednetworks.com>