

DWDM-SFP-10GE-80-34.25-A

10GBASE, SFP+, DWDM, ZR, (SM)
1480 NM - 1580 NM, 80 KM REACH, LC

DWDM-SFP-10GE-80-34.25-A

10GBASE, SFP+, DWDM, ZR Transceiver

Features

- Up to 11.3Gbps Data Links
- Up to 80km transmission on SMF
- DWDM EML Laser and APD receiver
- Metal enclosure, for lower EMI
- 2-wire interface with integrated Digital Diagnostic monitoring
- Hot-pluggable SFP+ footprint
- Specifications compliant with SFF 8472
- Compliant with SFP+ MSA with LC connector
- Single 3.3V power supply
- Case operating temperature range: 0°C to 70°C
- Power dissipation < 1.5Wp

1. Description

Approved Networks' SFP+-DWDM-ZR optical transceivers are Enhanced Small Form Factor Pluggable SFP+ transceivers designed for use in 10-Gigabit multi-rate links up to 80km of G.652 single mode fiber. They are compliant with SFF-8431, SFF-8432, and G.698.1 DS100S1-2Dz(C), and 10G Ethernet ZR and 10G Fibre Channel over 80km fiber. Digital diagnostics functions are available via a 2-wire serial interface, as specified in SFF-8472. The optical transceiver is compliant per the RoHS Directive 2011/65/EU.



Applications

- 10G Ethernet
- 10G SONET/SDH, OTU2/2e and 10G FC

Standard

- Compliant to SFF-8431
- RoHS Compliant.

C-band λ c Wavelength Guide Pin Descriptions

Channel	Wavelength (nm)	Frequency (THZ)	Channel	Wavelength (nm)	Frequency (THZ)
C17	1563.86	191.70	C39	1546.12	193.90
C18	1563.05	191.80	C40	1545.32	194.00
C19	1562.23	191.90	C41	1544.53	194.10
C20	1561.42	192.00	C42	1543.73	194.20
C21	1560.61	192.10	C43	1542.94	194.30
C22	1559.79	192.20	C44	1542.14	194.40
C23	1558.98	192.30	C45	1541.35	194.50
C24	1558.17	192.40	C46	1540.56	194.60
C25	1557.36	192.50	C47	1539.77	194.70
C26	1556.55	192.60	C48	1538.98	194.80
C27	1555.75	192.70	C49	1538.19	194.90
C28	1554.94	192.80	C50	1537.40	195.00
C29	1554.13	192.90	C51	1536.61	195.10
C30	1553.33	193.00	C52	1535.82	195.20
C31	1552.52	193.10	C53	1535.04	195.30
C32	1551.72	193.20	C54	1534.25	195.40
C33	1550.92	193.30	C55	1533.47	195.50
C34	1550.12	193.40	C56	1532.68	195.60
C35	1549.32	193.50	C57	1531.90	195.70
C36	1548.51	193.60	C58	1531.12	195.80
C37	1547.72	193.70	C59	1530.33	195.90
C38	1546.92	193.80	C60	1529.55	196.00
Non-ITU	Peak wavelength between 1528.77nm-1563.86		C61	1528.77	196.10

2. Absolute Maximum Ratings

Any stress beyond the maximum ratings can result in permanent damage. The device specifications are guaranteed only under the recommended operating conditions.

Parameter	Symbol	Min	Typ	Max	Unit
Storage Temperature	Ts	-40	-	85	°C
Relative Humidity	RH	5	-	95	%
Power Supply Voltage	VCC	-0.3	-	4	V
Signal Input Voltage		Vcc-0.3	-	Vcc+0.3	V

3. Recommended Operating Conditions

Parameter	Symbol	Min	Typ	Max	Unit	Notes
Case Operating Temperature	Tcase	0	-	70	°C	Commercial
Power Supply Voltage	VCC	3.14	3.3	3.47	V	
Power Supply Current	ICC	-		450	mA	
Data Rate	BR		10.3125		Gbps	
Transmission Distance	TD		-	80	Km	
Coupled fiber	Single mode fiber					9/125um SMF

4. Optical Characteristics

Transmitter						
Parameter	Symbol	Min	Typ	Max	Unit	Note
Average Optical Power	Pout	-1		4	dBm	1
Center Wavelength Spacing			100		GHz	2
Optical Wavelength	λ_c	$\lambda_c-0.1$		$\lambda_c+0.1$	nm	
Optical Extinction Ratio	ER	6.0			dB	
Side Mode Supression Ratio	SMSR	30			dB	
Average Launch Power	Poff			-30	dBm	
Transmitter and Dispersion Penalty	TDP			3.0	dB	
Output Eye Mask	Compliant with IEEE 802.3ae					
Receiver						
Parameter	Symbol	Min	Typ	Max	Unit	Note
Wavelength Range	λ_c	1480		1580	nm	
Receiver Sensitivity	Rsen			-23	dBm	3
Input Saturation Power (Overload)	Psat	-6			dBm	
LOS Assert	LOSA	-35			dBm	
LOS De-assert	LOSD			-26	dBm	
LOS Detect Hysteresis	PHYS	0.5			dB	

Notes:

1. Output power is power coupled into a 9/125 mm single-mode fiber.
2. Corresponds to approximately 0.8 nm.
3. Measured with a PRBS 2³¹-1 test pattern, @10.325Gb/s, BER<10⁻¹².

5. Electrical Characteristics

Parameter	Symbol	Min	Typ	Max	Unit	Notes
Supply Voltage	Vcc	3.14	3.3	3.46	V	
Supply Current	Icc			450	mA	
Transmitter						
Parameter	Symbol	Min	Typ	Max	Unit	Notes
Input differential impedance	ohm		100		Ω	1
Single ended data input swing	Vin,pp	120		820	mV	
Transmit Disable Voltage	VD	Vcc-1.3		Vcc	V	
Transmit Enable Voltage	VEN	Vee		Vee+ 0.8	V	2
TX_FAULT Voltage-High		Vcc-1.3		Vcc		
TX_FAULT Voltage-Low		Vee		Vee+ 0.8		
Transmit Disable Assert Time				10	us	
Receiver						
Parameter	Symbol	Min	Typ	Max	Unit	Notes
Differential data output swing	Vout,pp	350		850	mV	3
Data output rise time	tr	30			ps	4
Data output fall time	tf	30			ps	4
LOS Fault	VLOS fault	Vcc-1.3		VccHOST	V	5
LOS Normal	VLOS norm	Vee		Vee+0.8	V	5

Notes:

1. Connected directly to TX data input pins. AC coupled thereafter.
2. Or open circuit.
3. Into 100 ohms differential termination.
4. These are unfiltered 20-80% values
5. Loss Of Signal is LVTTTL. Logic 0 indicates normal operation; logic 1 indicates no signal detected.

6. Pin Description

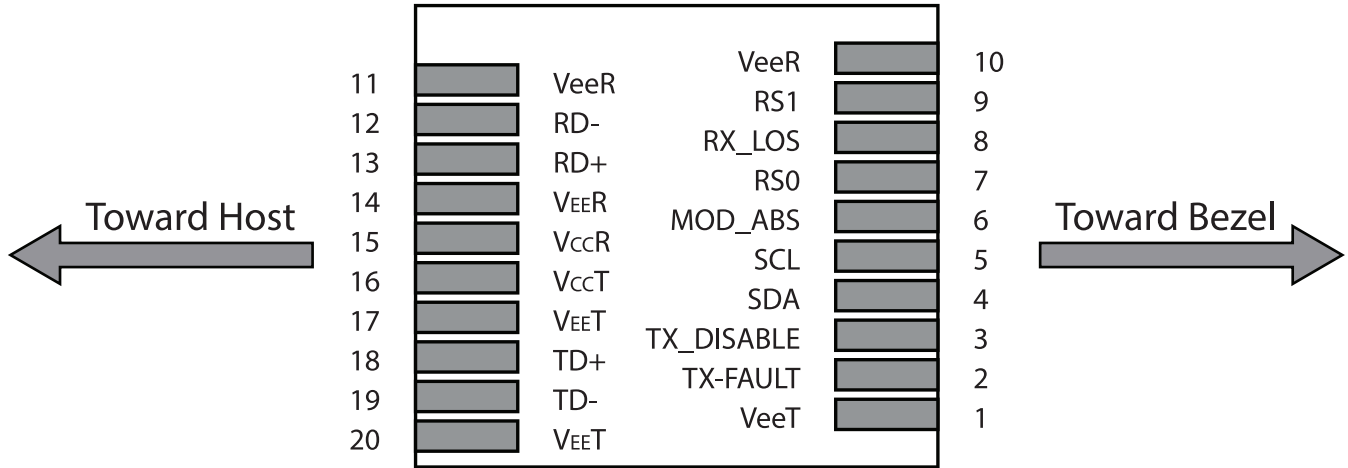

Figure 1. Pin out of Connector Block on Host Board

Pin	Symbol	Name/Description	Notes
1	VEET	Transmitter Ground (Common with Receiver Ground)	1
2	TFAULT	Transmitter Fault.	2
3	TDIS	Transmitter Disable. Laser output disabled on high or open.	3
4	SDA	2-wire Serial Interface Data Line	4
5	SCL	2-wire Serial Interface Clock Line	4
6	MOD_ABS	Module Absent. Grounded within the module	4
7	RS0	Rate Select 0	5
8	LOS	Loss of Signal indication. Logic 0 indicates normal operation.	6
9	RS1	No connection required	1
10	VEER	Receiver Ground (Common with Transmitter Ground)	1
11	VEER	Receiver Ground (Common with Transmitter Ground)	1
12	RD-	Receiver Inverted DATA out. AC Coupled	
13	RD+	Receiver Non-inverted DATA out. AC Coupled	
14	VEER	Receiver Ground (Common with Transmitter Ground)	1
15	VCCR	Receiver Power Supply	
16	VCCT	Transmitter Power Supply	
17	VEET	Transmitter Ground (Common with Receiver Ground)	1
18	TD+	Transmitter Non-Inverted DATA in. AC Coupled.	
19	TD-	Transmitter Inverted DATA in. AC Coupled.	
20	VEET	Transmitter Ground (Common with Receiver Ground)	1

Notes:

1. Circuit ground is internally isolated from chassis ground.
2. TFAULT is an open collector/drain output, which should be pulled up with a 4.7k – 10k Ohms resistor on the host board if intended for use. Pull up voltage should be between 2.0V to Vcc + 0.3V. A high output indicates a transmitter fault caused by either the TX bias current or the TX output power exceeding the preset alarm thresholds. A low output indicates normal operation. In the low state, the output is pulled to <0.8V.
3. Laser output disabled on TDIS >2.0V or open, enabled on TDIS <0.8V.
4. Should be pulled up with 4.7kΩ- 10kΩ host board to a voltage between 2.0V and 3.6V. MOD_ABS pulls line low to indicate module is plugged in.
5. Internally pulled down per SFF-8431 Rev 4.1.
6. LOS is open collector output. It should be pulled up with 4.7kΩ – 10kΩ on host board to a voltage between 2.0V and 3.6V. Logic 0 indicates normal operation; logic 1 indicates loss of signal.

7. Digital Diagnostic Functions

This transceiver supports the 2-wire serial communication protocol as defined in the SFP+ MSA. The standard SFP serial ID provides access to identification information that describes the transceiver's capabilities, standard interfaces, manufacturer, and other information.

Additionally, SFP+ transceivers provide a unique enhanced digital diagnostic monitoring interface, which allows real-time access to device operating parameters such as transceiver temperature, laser bias current, transmitted optical power, received optical power and transceiver supply voltage. It also defines a sophisticated system of alarm and warning flags, which alerts end-users when particular operating parameters are outside of a factory set normal range.

The SFP MSA defines a 256-byte memory map in EEPROM that is accessible over a 2-wire serial interface at the 8 bit address 1010000X (A0h). The digital diagnostic monitoring interface makes use of the 8 bit address 1010001X (A2h), so the originally defined serial ID memory map remains unchanged.

The operating and diagnostics information is monitored and reported by a Digital Diagnostics Transceiver Controller (DDTC) inside the transceiver, which is accessed through a 2-wire serial interface. When the serial protocol is activated, the serial clock signal (SCL, Mod Def 1) is generated by the host. The positive edge clocks data into the SFP transceiver into those segments of the EEPROM that are not write-protected. The negative edge clocks data from the SFP transceiver. The serial data signal (SDA, Mod Def 2) is bi-directional for serial data transfer. The host uses SDA in conjunction with SCL to mark the start and end of serial protocol activation. The memories are organized as a series of 8-bit data words that can be addressed individually or sequentially.

DWDM-SFP-10GE-80-34.25-A

10GBASE, SFP+, DWDM, ZR, (SM)

1480 NM - 1580 NM, 80 KM REACH, LC

8. Recommended Interface Circuit

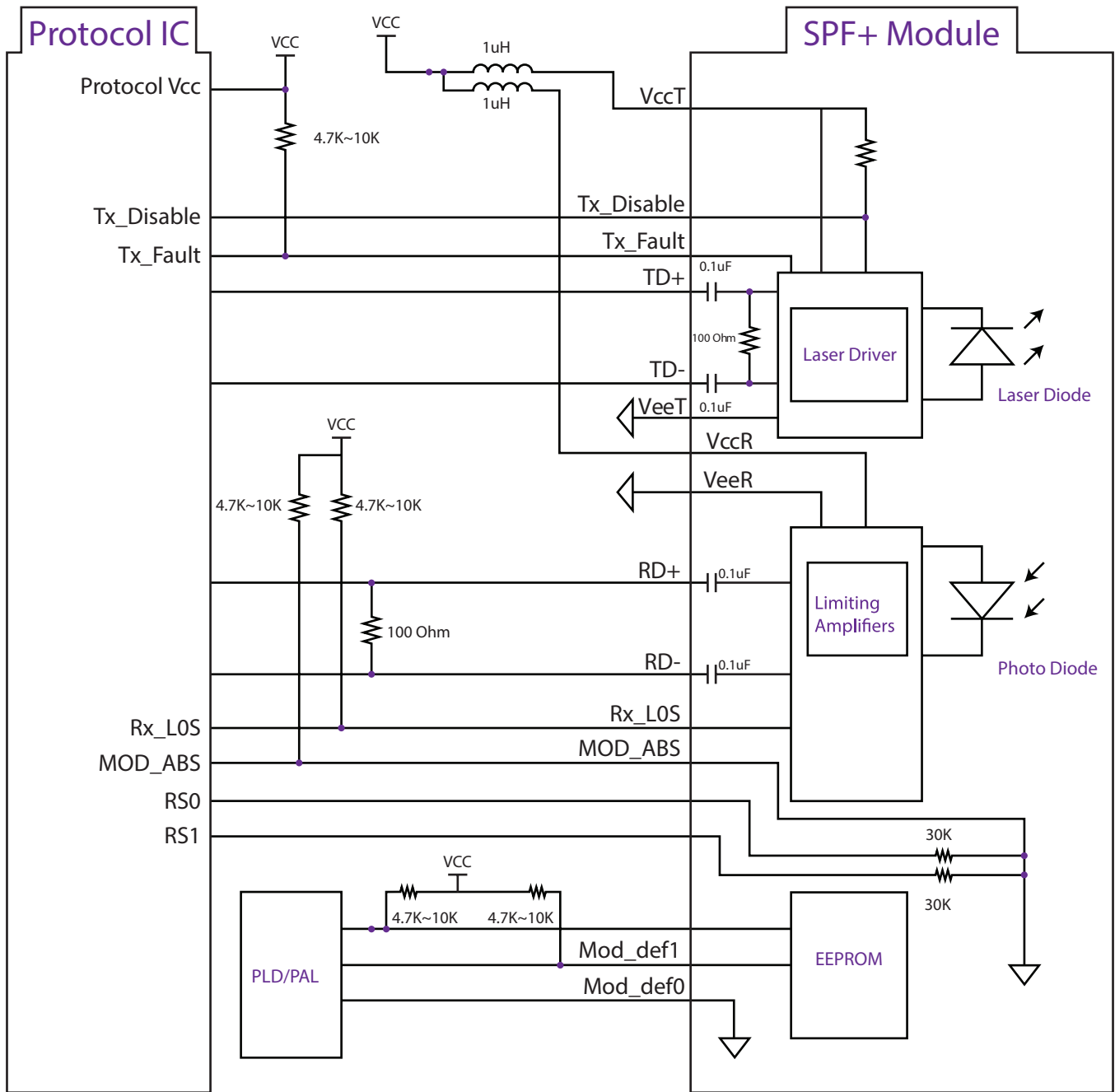

DWDM-SFP-10GE-80-34.25-A

10GBASE, SFP+, DWDM, ZR, (SM)
1480 NM - 1580 NM, 80 KM REACH, LC

9. Outline Dimentions

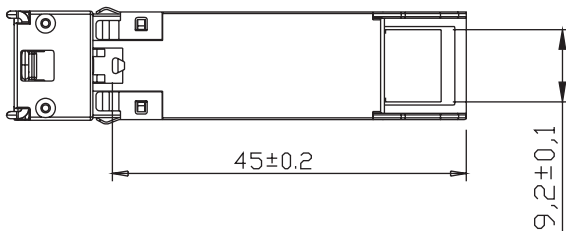
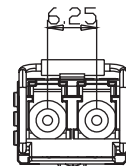
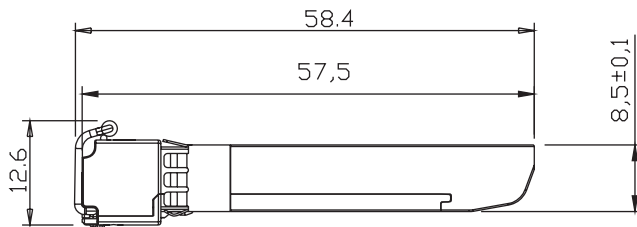
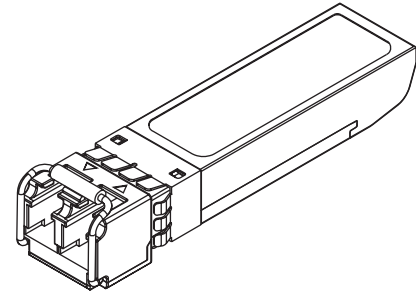
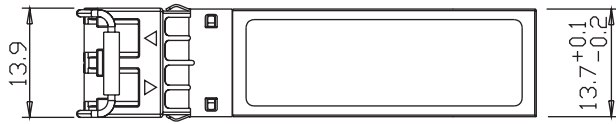

Units in MM

10. Regulatory Compliance

Feature	Reference	Performance
Electrostatic discharge (ESD)	IEC/EN 61000-4-2	Compatible with standards
Electromagnetic Interference (EMI)	FCC Part 15 Class B EN 55022 Class B (CISPR 22A)	Compatible with standards
Laser Eye Safety	FDA 21CFR 1040.10, 1040.11 IEC/EN 60825-1, 2	Class 1 laser product
Component Recognition	IEC/EN 60950, UL	Compatible with standards
ROHS	2002/95/EC	Compatible with standards
EMC	EN61000-3	Compatible with standards

DWDM-SFP-10GE-80-34.25-A

10GBASE, SFP+, DWDM, ZR, (SM)

1480 NM - 1580 NM, 80 KM REACH, LC

11. Contact Information

Approved Networks is a leading supplier of Network Transceivers and Connectivity products to Channel Partners, Resellers, and OEMs. With more than 9 years of direct industry experience, our products are resident in the most demanding and mission critical functional networks Worldwide. We serve as a Master Distributor to the largest CMs in the world and deploy the most rigorous testing and firmware management programs to bring the highest level of functional product to the market at a cost that makes sense.

Corporate Offices: **Approved Networks, Inc.**

Tel: 800.590.9535

Web: <http://www.approvednetworks.com>