

## CWDM-SFP10G-1530-A

10GBASE, SFP+, CWDM, ER, (SM)  
1470 NM - 1610 NM, 40 KM REACH, LC

## CWDM-SFP10G-1530-A

10GBASE, SFP+, CWDM, ER Transceiver

### Features

- Up to 11.3Gbps Data Links
- Up to 40km transmission on SMF
- Power dissipation < 1.5W
- CWDM EML Laser and PIN receiver
- Metal enclosure, for lower EMI
- 2-wire interface with integrated Digital Diagnostic monitoring
- Hot-pluggable SFP+ footprint
- Specifications compliant with SFF 8472
- Compliant with SFP+ MSA with LC connector
- Single 3.3V power supply
- Case operating temperature range: 0°C to 70°C

### 1. Description

The 10GBASE SFP+ CWDM series optical transceiver is designed for fiber communications application up to 10G, which fully compliant with the specification of SFP+ MSA SFF-8431. This module is designed for single mode fiber and operates at a nominal wavelength of CWDM wavelength. There are eight center wavelengths available from 1470nm to 1610nm. The module is with the SFP+ connector to allow hot plug capability. Only single 3.3V power supply is needed. The optical output can be disabled by LVTTTL logic high-level input of TX\_DIS. Loss of signal (RX\_LOS) output is provided to indicate the loss of an input optical signal of receiver. This module provides digital diagnostic functions via a 2-wire serial interface as defined by the SFF-8472 specification.



### Applications

- 10GBASE-ER/EW & 10G Ethernet
- 10G SONET/SDH, OTU2/2e and 10G FC

### Standard

- Compliant to 802.3ae 10GBASE-ER/EW
- Compliant to SFF-8431
- RoHS Compliant.

## 2. Absolute Maximum Ratings

Any stress beyond the maximum ratings can result in permanent damage. The device specifications are guaranteed only under the recommended operating conditions.

| Parameter            | Symbol | Min     | Typ | Max     | Unit |
|----------------------|--------|---------|-----|---------|------|
| Storage Temperature  | Ts     | -40     | -   | 85      | °C   |
| Relative Humidity    | RH     | 5       | -   | 95      | %    |
| Power Supply Voltage | VCC    | -0.3    | -   | 4       | V    |
| Signal Input Voltage |        | Vcc-0.3 | -   | Vcc+0.3 | V    |

## 3. Recommended Operating Conditions

| Parameter                  | Symbol            | Min  | Typ     | Max  | Unit | Notes            |
|----------------------------|-------------------|------|---------|------|------|------------------|
| Case Operating Temperature | Tcase             | 0    | -       | 70   | °C   | Without air flow |
| Power Supply Voltage       | VCC               | 3.14 | 3.3     | 3.47 | V    |                  |
| Power Supply Current       | ICC               | -    |         | 450  | mA   |                  |
| Data Rate                  | BR                |      | 10.3125 |      | Gbps |                  |
| Transmission Distance      | TD                |      | -       | 40   | km   |                  |
| Coupled fiber              | Single mode fiber |      |         |      |      | 9/125um SMF      |

## 4. Optical Characteristics

| Transmitter                       |                             |               |     |               |       |      |
|-----------------------------------|-----------------------------|---------------|-----|---------------|-------|------|
| Parameter                         | Symbol                      | Min           | Typ | Max           | Unit  | Note |
| Average Launched Power            | Pout                        | -1            |     | 3             | dBm   | 1    |
| Extinction Ratio                  | ER                          | 6             |     |               | dB    |      |
| Optical Wavelength                | $\lambda_c$                 | $\lambda-6.5$ |     | $\lambda+6.5$ | nm    | 2    |
| Spectrum Band Width (-20dB)       | $\sigma$                    |               |     | 1.0           | nm    |      |
| Side Mode Suppression Ratio       | SMSR                        | 30            |     |               | dB    |      |
| RIN                               | RIN                         |               |     | -128          | dB/Hz |      |
| Output Eye Mask                   | Compliant with IEEE 802.3ae |               |     |               |       |      |
| Receiver                          |                             |               |     |               |       |      |
| Parameter                         | Symbol                      | Min           | Typ | Max           | Unit  | Note |
| Input Optical Wavelength          | $\lambda$                   | 1270          |     | 1610          | nm    |      |
| Receiver Sensitivity              | Psen                        |               |     | -15.8         | dBm   | 2    |
| Input Saturation Power (Overload) | Psat                        | 0.5           |     |               | dBm   |      |
| LOS Assert                        | LOSA                        | -30           |     |               | dBm   |      |
| LOS De-assert                     | LOSD                        |               |     | -17           | dBm   |      |
| LOS Detect Hysteresis             | PHYS                        | 0.5           |     |               | dB    |      |

**Notes**

1. Class 1 Laser Safety per FDA/CDRH and IEC-825-1 regulations.
2. “λ”is:1470,1490,1510,1530,1550,1570,1590,1610, please the “product selection”.
3. Measured with a PRBS 2<sup>31</sup> -1 test pattern, @10.325Gb/s, BER<10<sup>-12</sup>

**5. Electrical Characteristics**

| Parameter                      | Symbol     | Min     | Typ    | Max      | Unit | Notes |
|--------------------------------|------------|---------|--------|----------|------|-------|
| Supply Voltage                 | Vcc        | 3.14    | 3.3 3. | 46       | V    |       |
| Supply Current                 | Icc        |         |        | 450      | mA   |       |
| Transmitter                    |            |         |        |          |      |       |
| Parameter                      | Symbol     | Min     | Typ    | Max      | Unit | Notes |
| Input differential impedance   | Rin        |         | 100    |          | Ω    | 1     |
| Single ended data input swing  | Vin,pp     | 180     |        | 1200     | mV   |       |
| Transmit Disable Voltage       | VD         | Vcc-1.3 |        | Vcc      | V    |       |
| Transmit Enable Voltage        | VEN        | Vee     |        | Vee+ 0.8 | V    | 2     |
| Transmit Disable Assert Time   |            |         |        | 10       | us   |       |
| Receiver                       |            |         |        |          |      |       |
| Parameter                      | Symbol     | Min     | Typ    | Max      | Unit | Notes |
| Differential data output swing | Vout,pp    | 300     |        | 850      | mV   | 3     |
| Data output rise time          | tr         | 30      |        |          | ps   | 4     |
| Data output fall time          | tf         | 30      |        |          | ps   | 4     |
| LOS Fault                      | VLOS fault | Vcc-1.3 |        | VccHOST  | V    | 5     |
| LOS Normal                     | VLOS norm  | Vee     |        | Vee+0.8  | V    | 5     |
| Power Supply Rejection         | PSR        | 100     |        |          | mVpp | 6     |

**Notes:**

2. Connected directly to TX data input pins. AC coupled thereafter.
3. Or open circuit.
4. Into 100 ohms differential termination.
5. 5. 20 – 80 %.
6. 6. Loss Of Signal is LVTTTL. Logic 0 indicates normal operation; logic 1 indicates no signal detected.

**6. Pin Description**

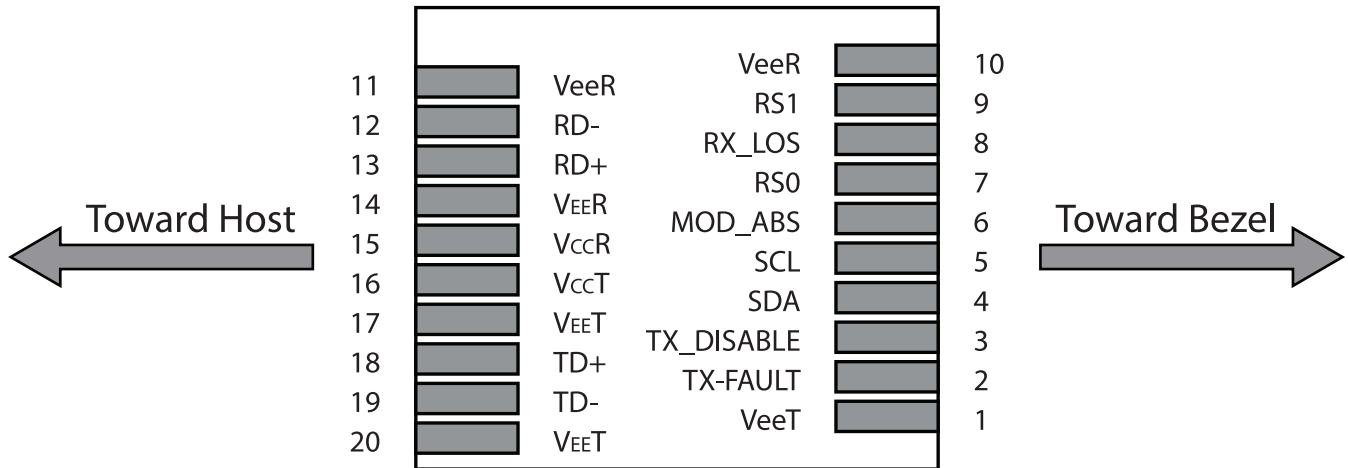

Figure 1. Pin out of Connector Block on Host Board

| Pin | Symbol  | Name/Description   | Notes |
|-----|---------|--|-------|
| 1   | VEET    | Transmitter Ground (Common with Receiver Ground)               | 1     |
| 2   | TFAULT  | Transmitter Fault.   | 2     |
| 3   | TDIS    | Transmitter Disable. Laser output disabled on high or open.    | 3     |
| 4   | SDA     | 2-wire Serial Interface Data Line                              | 4     |
| 5   | SCL     | 2-wire Serial Interface Clock Line                             | 4     |
| 6   | MOD_ABS | Module Absent. Grounded within the module                      | 4     |
| 7   | RS0     | Rate Select 0  | 5     |
| 8   | LOS     | Loss of Signal indication. Logic 0 indicates normal operation. | 6     |
| 9   | RS1     | No connection required   | 1     |
| 10  | VEER    | Receiver Ground (Common with Transmitter Ground)               | 1     |
| 11  | VEER    | Receiver Ground (Common with Transmitter Ground)               | 1     |
| 12  | RD-     | Receiver Inverted DATA out. AC Coupled                         |       |
| 13  | RD+     | Receiver Non-inverted DATA out. AC Coupled                     |       |
| 14  | VEER    | Receiver Ground (Common with Transmitter Ground)               | 1     |
| 15  | VCCR    | Receiver Power Supply  |       |
| 16  | VCCT    | Transmitter Power Supply                                       |       |
| 17  | VEET    | Transmitter Ground (Common with Receiver Ground)               | 1     |
| 18  | TD+     | Transmitter Non-Inverted DATA in. AC Coupled.                  |       |
| 19  | TD-     | Transmitter Inverted DATA in. AC Coupled.                      |       |
| 20  | VEET    | Transmitter Ground (Common with Receiver Ground)               | 1     |

**Notes:**

1. Circuit ground is internally isolated from chassis ground.
2. TFAULT is an open collector/drain output, which should be pulled up with a 4.7k – 10k Ohms resistor on the host board if intended for use. Pull up voltage should be between 2.0V to Vcc + 0.3V. A high output indicates a transmitter fault caused by either the TX bias current or the TX output power exceeding the preset alarm thresholds. A low output indicates normal operation. In the low state, the output is pulled to <0.8V.
3. Laser output disabled on TDIS >2.0V or open, enabled on TDIS <0.8V.
4. Should be pulled up with 4.7kΩ- 10kΩ host board to a voltage between 2.0V and 3.6V. MOD\_ABS pulls line low to indicate module is plugged in.
5. Internally pulled down per SFF-8431 Rev 4.1.
6. LOS is open collector output. It should be pulled up with 4.7kΩ – 10kΩ on host board to a voltage between 2.0V and 3.6V. Logic 0 indicates normal operation; logic 1 indicates loss of signal.

**7. Digital Diagnostic Functions**

This transceiver supports the 2-wire serial communication protocol as defined in the SFP+ MSA. The standard SFP serial ID provides access to identification information that describes the transceiver's capabilities, standard interfaces, manufacturer, and other information.

Additionally, SFP+ transceivers provide a unique enhanced digital diagnostic monitoring interface, which allows real-time access to device operating parameters such as transceiver temperature, laser bias current, transmitted optical power, received optical power and transceiver supply voltage. It also defines a sophisticated system of alarm and warning flags, which alerts end-users when particular operating parameters are outside of a factory set normal range.

The SFP MSA defines a 256-byte memory map in EEPROM that is accessible over a 2-wire serial interface at the 8 bit address 1010000X (A0h). The digital diagnostic monitoring interface makes use of the 8 bit address 1010001X (A2h), so the originally defined serial ID memory map remains unchanged.

The operating and diagnostics information is monitored and reported by a Digital Diagnostics Transceiver Controller (DDTC) inside the transceiver, which is accessed through a 2-wire serial interface. When the serial protocol is activated, the serial clock signal (SCL, Mod Def 1) is generated by the host. The positive edge clocks data into the SFP transceiver into those segments of the E2PROM that are not write-protected. The negative edge clocks data from the SFP transceiver. The serial data signal (SDA, Mod Def 2) is bi-directional for serial data transfer. The host uses SDA in conjunction with SCL to mark the start and end of serial protocol activation. The memories are organized as a series of 8-bit data words that can be addressed individually or sequentially.

# CWDM-SFP10G-1530-A

10GBASE, SFP+, CWDM, ER, (SM)

1470 NM - 1610 NM, 40 KM REACH, LC

## 8. Recommended Interface Circuit

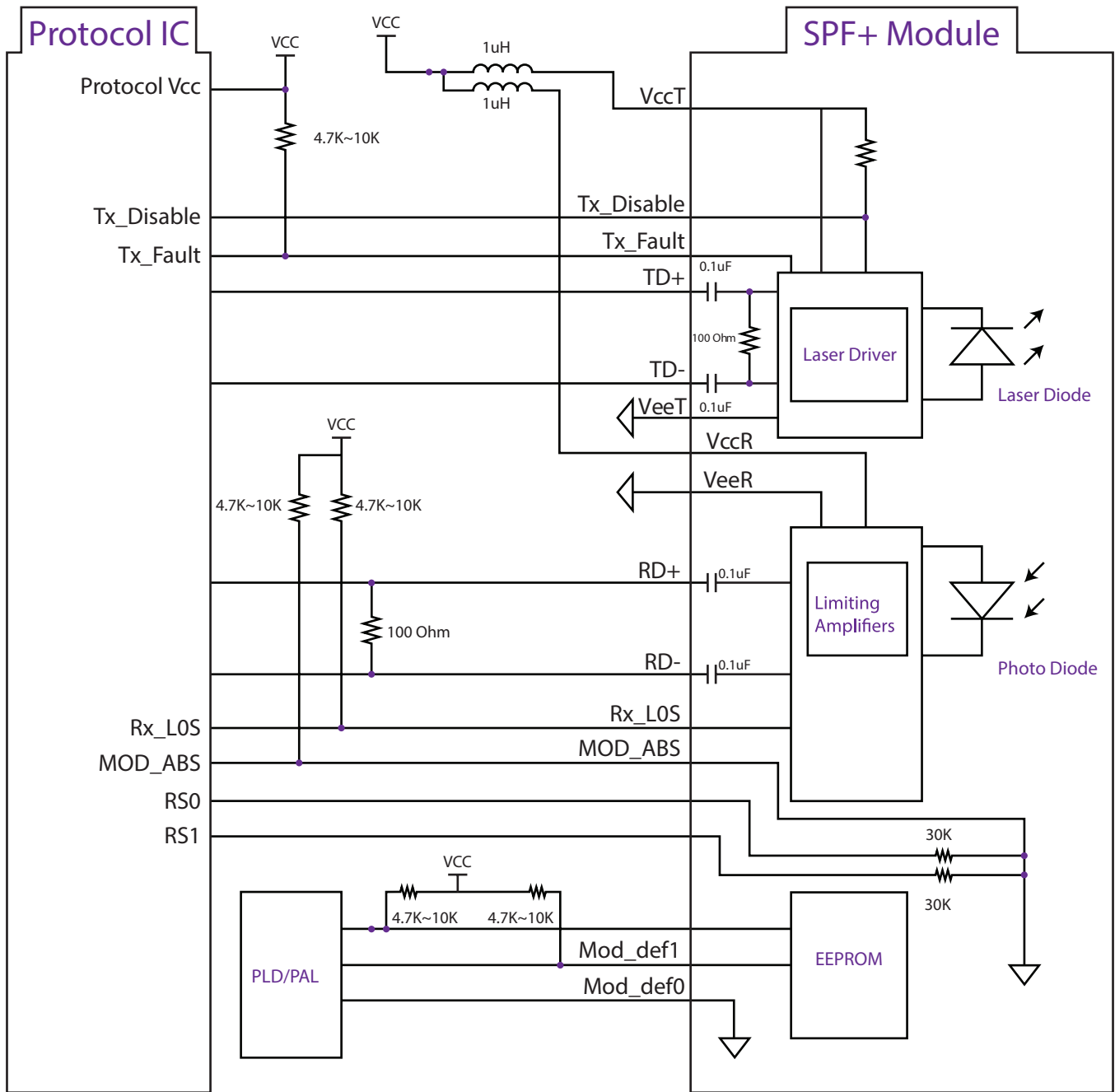

# CWDM-SFP10G-1530-A

10GBASE, SFP+, CWDM, ER, (SM)

1470 NM - 1610 NM, 40 KM REACH, LC

## 9. Outline Dimentions

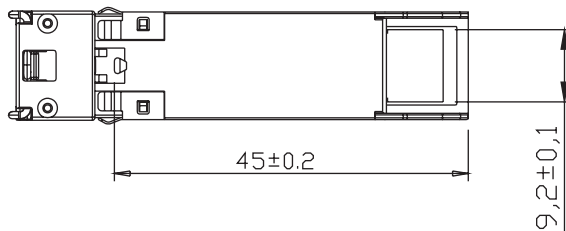
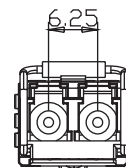
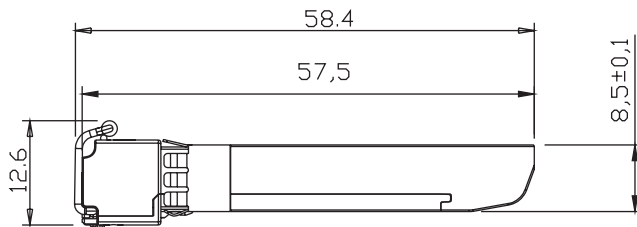
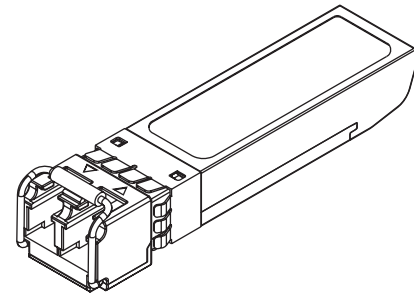
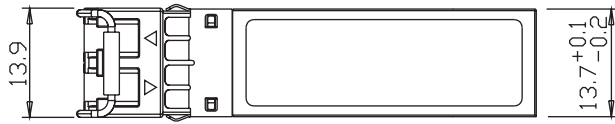

Units in MM

## 10. Regulatory Compliance

| Feature                            | Reference   | Performance               |
|------------------------------------|---|---------------------------|
| Electrostatic discharge (ESD)      | IEC/EN 61000-4-2                                    | Compatible with standards |
| Electromagnetic Interference (EMI) | FCC Part 15 Class B EN 55022<br>Class B (CISPR 22A) | Compatible with standards |
| Laser Eye Safety                   | FDA 21CFR 1040.10, 1040.11<br>IEC/EN 60825-1, 2     | Class 1 laser product     |
| Component Recognition              | IEC/EN 60950, UL                                    | Compatible with standards |
| ROHS                               | 2002/95/EC  | Compatible with standards |
| EMC                                | EN61000-3   | Compatible with standards |

## CWDM-SFP10G-1530-A

10GBASE, SFP+, CWDM, ER, (SM)

1470 NM - 1610 NM, 40 KM REACH, LC

### 11. Contact Information

Approved Networks is a leading supplier of Network Transceivers and Connectivity products to Channel Partners, Resellers, and OEMs. With more than 9 years of direct industry experience, our products are resident in the most demanding and mission critical functional networks Worldwide. We serve as a Master Distributor to the largest CMs in the world and deploy the most rigorous testing and firmware management programs to bring the highest level of functional product to the market at a cost that makes sense.

Corporate Offices: **Approved Networks, Inc.**

Tel: 800.590.9535

Web: <http://www.approvednetworks.com>