

C3-XENPAK10GB-LR-A

10GBASE, XENPAK LR, (SM)
1310NM, 10KM REACH, SC

C3-XENPAK10GB-LR-A

10GBASE XENPAK LR Transceiver

Features

- Compatible with XENPAK MSA Rev.3.0
- Support of IEEE802.3ae 10GBASE-LR
- Transmission Distance up to 10km(SMF)
- Uncooled directly modulated 1310nm DFB Laser
- Temperature Range 0 to 70°C
- Adaptable Power Supply (APS:+1.2V)
- SC duplex Optical connector
- Hot pluggable 70-pin connector with XAUI electrical interface
- Management and control via MDIO 2-wire interface
- Compatible with RoHS



Applications

- 10GBASE-LR 10G Ethernet

1. Product Description

The 10GBASE-XENPAK-LR is a highly integrated Serial optical transponder module for high-speed, 10Gbit/s data transmission applications. 4x3.125Gbps Ethernet Signal Input by XAUI Interface. An integrated Coder / Decoder and multiplexer / demultiplexer (SERDES: Serializer / Deserializer). Designing for 10GBASE-LR Transmission with an uncooled directly modulated 1310nm DFB Laser. The transponder operates within a wide case temperature range of 0°C to +70°C and offers optimum heat dissipation and excellent electromagnetic shielding which enables high port densities for 10 GbE systems. A 70 pin electrical connector and a duplex SC connector optical interface assure that connectivity is compliant to the XENPAK MSA Rev.3.0.

2. Absolute Maximum Ratings

Any stress beyond the maximum ratings can result in permanent damage. The device specifications are guaranteed only under the recommended operating conditions.

Parameter	Symbol	Min	Max	Unit	Notes
Storage Ambient Temperature Range		-40	+85	°C	
Powered case Temperature Range		0	+70	°C	
Supply Voltage APS	Vaps	0	1.5	V	
Supply Voltage Range @ 3.3V	Vcc3	-0.5	4.0	V	

3. Recommended Operating Conditions

Parameter	Symbol	Min	Typical	Max	Unit
Operating Case Temperature	Tc	0		+70	°C
Power Supply Voltage	VCC3	3.13	3.3	3.47	V
	VAPS	1.152	1.2	1.248	
Power Dissipation	PD		3.5	4	W

4. Electrical DC Characteristics

(VCC3=3.14V to 3.47V,VCCaps=1.152V to 1.248V,Tc=0 to 70)						
Parameter	Symbol	Min	Typical	Max	Unit	
1.2V CMOS(1.8V CMOS Compatible1)I/O DC Characteristics (PRTAD;LASI;RESET;TX_ONOFF)						
Output High Voltage	Voh	1			V	
Output Low Voltage	Vol			0.15	V	
Input High Voltage	Vih	0.84	1.5	V		
Input Low Voltage	Vil			0.36	V	
Input Pull-down Current	Ipd	20		120	uA	
XAUI I/O DC Characteristics (TXLANE[0..3]; RXLANE[0..3])						
Differential Input Amplitude (pk-pk) 4)		220		1600	mV	
Differential Output Amplitude (pk-pk) 4)		800		1600		
MDIO I/O DC Characteristics (MDIO; MDC)						
Output Low Voltage	VOL	-0.3		0.2	V	
Output Low Current	IOL			20	mA	
Input High Voltage	VIH	0.84		1.5	V	
Input Low Voltage	VIL	-0.3		0.36	V	

Notes:

- For 1.8 V CMOS Voh = 1.65 V min., Vol = 0.15 V max., Vih = 1.17 V min., Vil = 0.63 V max.

2. Rpull-up = 10 kΩ to 1.8 V.

3. Vin = 1.8 V.

4. AC coupled

5. Electrical AC Characteristics

(VCC3 = 3.14 V to 3.47 V, VCC aps = 1.152 V to 1.248 V, TC = 0°C to 70°C)						
Parameter	Symbol	Min	Typ	Max	Unit	
XAUI Input AC Characteristics (TXLANE[0..3])						
XAUI Baud Rate	DRin		3.125		Gbit/s	
Differential Input Impedance	ZIN	80	100	120	Ω	
XAUI Output AC Characteristics (RXLANE[0..3])						
XAUI Baud Rate	DRout		3.125		Gbit/s	
XAUI Eye Mask (far-end)	According to IEEE 802.3ae					
Output Differential Impedance	ZO	80	100	120	Ω	
Total Jitter ⁴⁾	TJXAUI			0.35	UI	
Deterministic Jitter ⁴⁾	DJXAUI			0.37	UI	
Power-On Reset AC Characteristics						
Power-On Reset AC Characteristics	According to XENPAK MSA Issue 3.0, 2002-9-18					
MDIO I/O AC Characteristics (MDIO; MDC)						
MDIO Data Hold Time	tHOLD	10			ns	
MDIO Data Setup Time	tSU	10			ns	
Delay from MDC Rising Edge to MDIO Data Change	tDELAY			300	ns	
MDC Clock Rate	fMAX			2.5	MHz	

Notes:

1. 100 MHz to 2.5 GHz
2. At crossing point
3. Per IEEE Std 802.3ae
4. At near-end, No pre-equalization, 1 UI = 320 ps.

6. Optical Interface Operating Conditions

Parameter	Fiber Type	Symbol	Min	Typ	Max	Units
Operating range	Single Mode Fiber	Lop	2		10,000	m
Data Rate	10GBASE-LRmodule	DR0		10.3125		Gbps

7. Optical Characteristics

(VCC3 = 3.14 V to 3.47 V, VCC aps = 1.152 V to 1.248 V, TC = 0°C to 70°C, BER1E-12, Bit Rate 10.3125)					
Parameter	Symbol	Min	Typ	Max	Unit
Transmitter					
Average Launch Power	PAvg	-8.2		-0.5	dBm
Transmitter and Dispersion Penalty	TDP			3.2	dB
Center Wavelength Range (1)	λ	1260	1310	1355	nm
SMSR	SWSR	30			dB
Extinction Ratio	ER	4.0	6		dB
Relative Intensity Noise ¹² OMA	RIN			-128	dB/Hz
Eye Mask Definition	According to IEEE 802.3ae				
Optical Return Loss Tolerance	ORLT			12	dB
Average Launch Power of OFF Transmitter	Poff			-30	dBm
Receiver					
Stressed Receiver Sensitivity in OMA	Pssen			-10.3	dBm
Receiver Sensitivity (in OMA ²)	Psen			-12.6	dBm
Power Overload	Po	0.5			dBm
Signal Detect Assert Level	PSD			-13	dBm
Signal Detect Hysteresis	PSD	1			dB
Center Wavelength Range	λ	1260		1355	nm

Notes:

1. Conforms to IEEE triple trade-off between center wavelength, RMS spectral width and minimum OMA.
2. Receiver sensitivity, which is defined for an ideal input signal is informative only.

8. Electrical PAD Layout

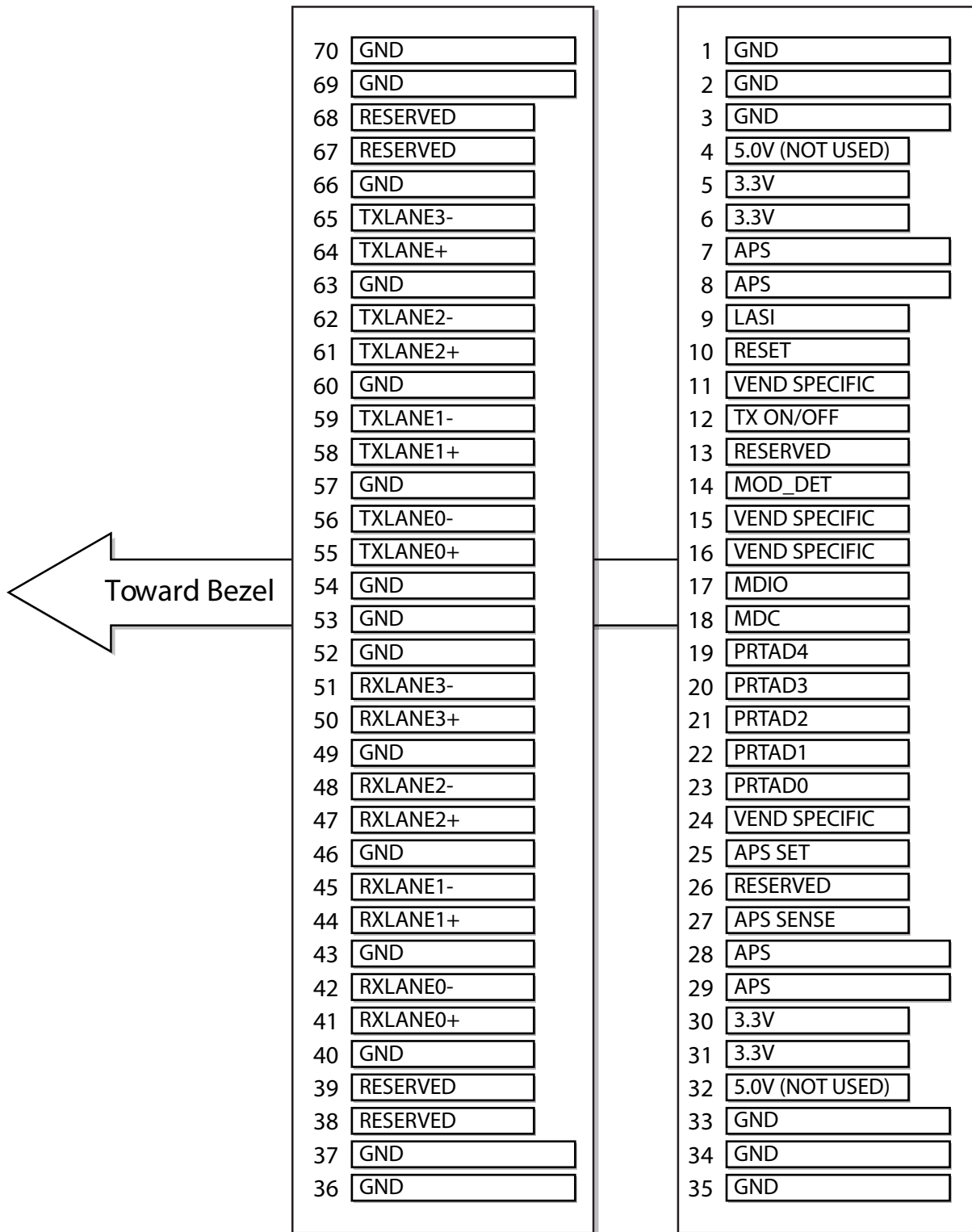

Top of Transceiver PCB



























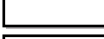
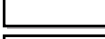
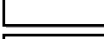
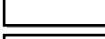
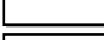
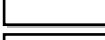
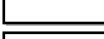
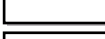
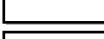
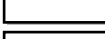
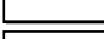
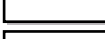
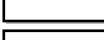
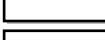
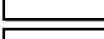
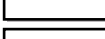
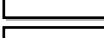
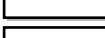
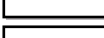
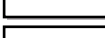
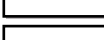
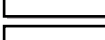
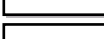
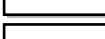
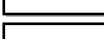
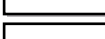
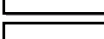
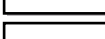

Bottom of Transceiver PCB
(Viewed through top)

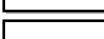
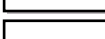
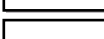
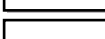
C3-XENPAK10GB-LR-A

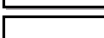
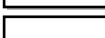
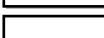
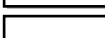
10GBASE, XENPAK LR, (SM)

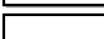
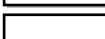
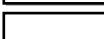
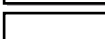
1310NM, 10KM REACH, SC

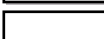
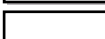
9. Host PCB XENPAK PINOUT

1		GND	GND		70
2		GND	GND		69
3		GND	RESERVED		68
4		5.0V (NOT USED)	RESERVED		67
5		3.3V	GND		66
6		3.3V	TXLANE3-		65
7		APS	TXLANE+		64
8		APS	GND		63
9		LASI	TXLANE2-		62
10		RESET	TXLANE2+		61
11		VEND SPECIFIC	GND		60
12		TX ON/OFF	TXLANE1-		59
13		RESERVED	TXLANE1+		58
14		MOD_DET	GND		57
15		VEND SPECIFIC	TXLANE0-		56
16		VEND SPECIFIC	TXLANE0+		55
17		MDIO	GND		54
18		MDC	GND		53
19		PRTAD4	GND		52
20		PRTAD3	RXLANE3-		51
21		PRTAD2	RXLANE3+		50
22		PRTAD1	GND		49
23		PRTAD0	RXLANE2-		48
24		VEND SPECIFIC	RXLANE2+		47
25		APS SET	GND		46
26		RESERVED	RXLANE1-		45
27		APS SENSE	RXLANE1+		44
28		APS	GND		43
29		APS	RXLANE0-		42
30		3.3V	RXLANE0+		41
31		3.3V	GND		40
32		5.0V (NOT USED)	RESERVED		39
33		GND	RESERVED		38
34		GND	GND		37
35		GND	GND		36

10. Pin Descriptions

Signal Name	Level	I/O	Pin NO.	Description
GND			1,2,3,33,34,35,36,37,40,43,46,49,52,53,54,57,60,63,66,69,70	Ground connection for signal ground on the module
APS	+1.2V		7,8,28,29	Input from Adaptive Power Supply
APS SENSE	+1.2V		27	APS Sense Output. Connected to the APS Sense Output. Connected to the APS input from APS
APS SET			25	Feedback input from APS. Connected to GND through a 1.18Kohm resistor inside the transponder.
3.3V	+3.3 V DC		5,6,30,31	DC Power Input,+5.0 V DC, Normal
Reserved			25	Reserved for APD
Reserved			13	Reserved
MDIO	Open Drain	I/O	17	Management Data I/O.Requires external 10-22KΩ pull-up to the APS on host
MDC	1.2V CMOS	I	18	Management Data Clock Input
PRTAD4	1.2V CMOS	I	19	Port Address Input bit 4
PRTAD3	1.2V CMOS	I	20	Port Address Input bit 3
PRTAD2	1.2V CMOS	I	21	Port Address Input bit 2
PRTAD1	1.2V CMOS	I	22	Port Address Input bit 1
PRTAD0	1.2V CMOS	I	23	Port Address Input bit 0
LASI	Open Drain	O	9	Link Alarm Status Interrupt Output. Open Drain Compatible Output with 10 - 20 kΩ pull-up on host. Logic high = Normal Operation Logic low = Status Flag Triggered
RESET	Open Drain	I	10	Reset Input. Open Drain Compatible Input with 22 kΩ pull-up to APS internal to transponder. Logic high = Normal Operation Logic low = RESET
Vendor Specific			11,15,16,24	Vendor Specific Pins. Leave unconnected when not used.
TX ON/OFF	Open Drain	I	12	TX ON/OFF Input. Open Drain Compatible Input with 22 kΩ pull-up to APS internal to transponder. Logic high = Transmitter On Logic low = Transmitter Off

Signal Name	Level	I/O	Pin NO.	Description
MOD DETECT		O	14	Pulled low inside transponder through a 1 kΩ resistor to Ground
Reserved		I	67,68,38,39	Reserved For Future Use
TX LANE 3– TX LANE 3+		I	65 64	Module XAUI Input Lane 3– Module XAUI Input Lane 3+
TX LANE 2– TX LANE 2+		I	62 61	Module XAUI Input Lane 2– Module XAUI Input Lane 2+
TX LANE 1– TX LANE 1+		I	59 58	Module XAUI Input Lane 1– Module XAUI Input Lane 1+
TX LANE 0– TX LANE 0+		I	56 55	Module XAUI Input Lane 0– Module XAUI Input Lane 0+
RX LANE 0+ RX LANE 0–		O	41 42	Module XAUI Output Lane 0+ Module XAUI Output Lane 0–
RX LANE 1+ RX LANE 1–		O	44 45	Module XAUI Output Lane 1+ Module XAUI Output Lane 1–
RX LANE 2+ RX LANE 2–		O	47 48	Module XAUI Output Lane 2+ Module XAUI Output Lane 2–
RX LANE 3+ RX LANE 3–		O	50 51	Module XAUI Output Lane 3+ Module XAUI Output Lane 3–

11. Block Diagram of Adapter Power Supply Circuit

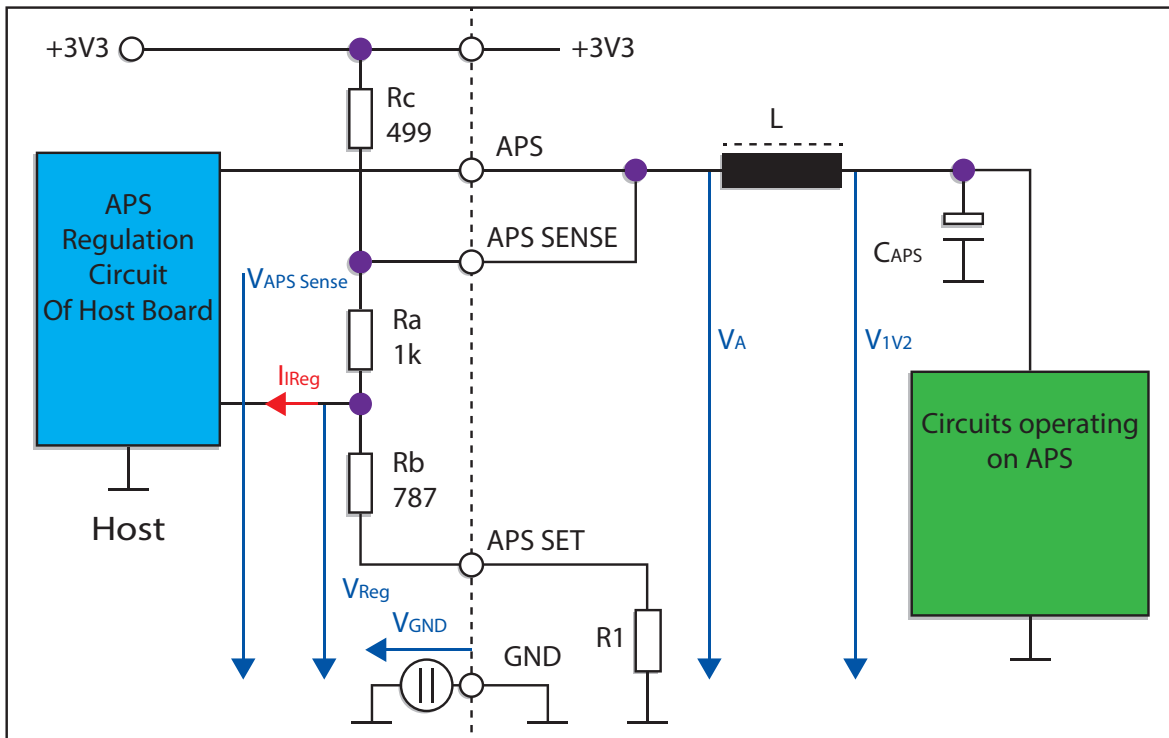

C3-XENPAK10GB-LR-A

10GBASE, XENPAK LR, (SM)
1310NM, 10KM REACH, SC

12. Eye Safety

This laser based multimode transceiver is a Class 1 product. It complies with IEC 60825-1 Ed.2: 2007 and FDA performance standards for laser products (21 CFR 1040.10 and 1040.11) except for deviations pursuant to Laser Notice 50, dated June 24, 2007.

13. Package Outline

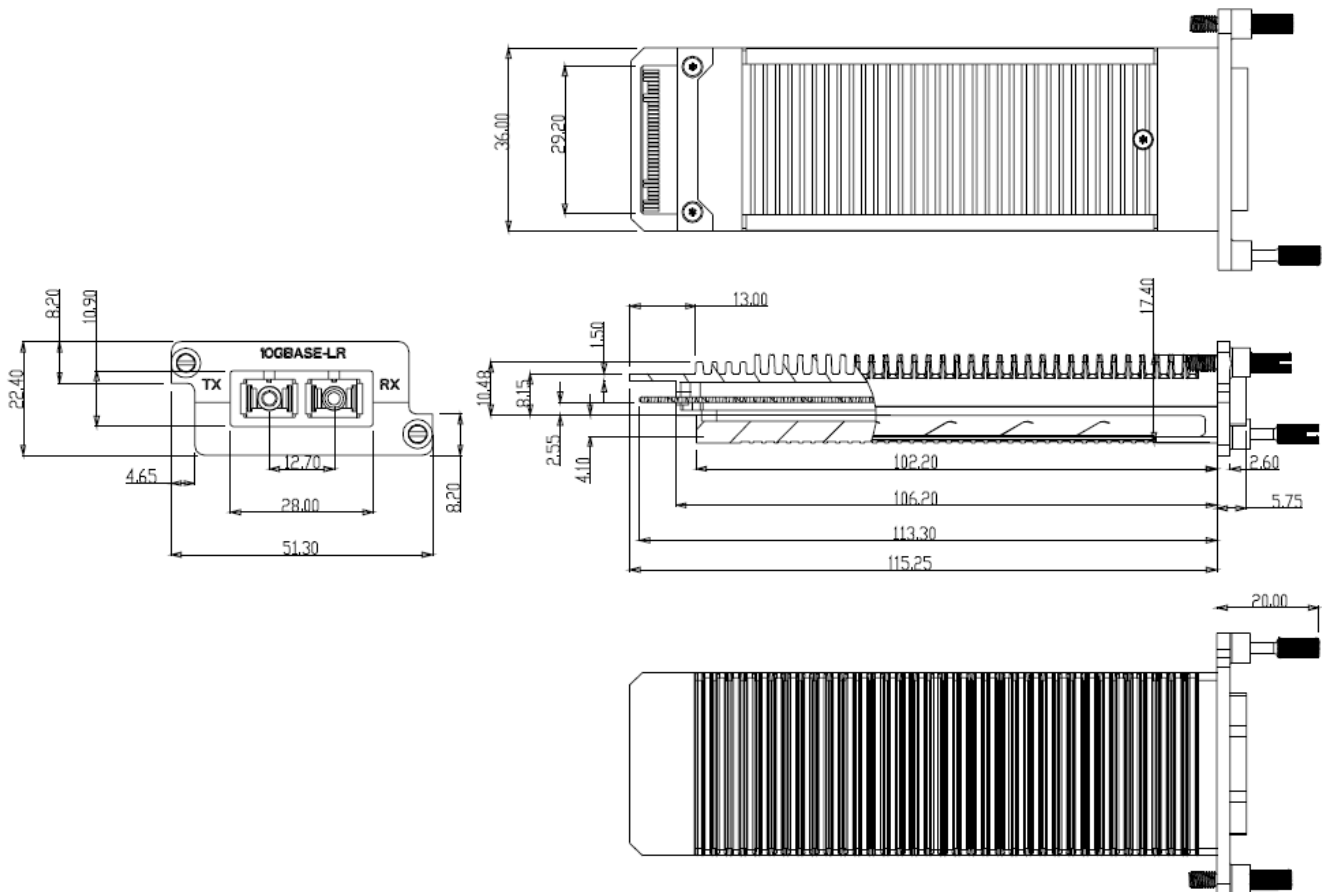

14. Contact Information

Approved Networks is a leading supplier of Network Transceivers and Connectivity products to Channel Partners, Resellers, and OEMs. With more than 9 years of direct industry experience, our products are resident in the most demanding and mission critical functional networks Worldwide. We serve as a Master Distributor to the largest CMs in the world and deploy the most rigorous testing and firmware management programs to bring the highest level of functional product to the market at a cost that makes sense.

Corporate Offices: **Approved Networks, Inc.**

Tel: 800.590.9535

Web: <http://www.approvednetworks.com>