

81Y1620-A
1000BASE, SFP-T Transceiver

Features

- Up to 1.25Gb/s bi-directional data links
- Hot-pluggable SFP footprint
- Commercial case temperature range (0°C to +70°C)
- Fully metallic enclosure for low EMI
- Low power dissipation
- Compact RJ-45 connector assembly
- Detailed product information in EEPROM
- +3.3V single power supply
- Access to physical layer IC via 2-wire serial bus
- Compliant with SFP MSA
- Compliant with IEEE Std 802.3TM-2002
- Compliant with FCC 47 CFR Part 15, Class B
- RoHS Compliant

1. Description

Approved Networks' 1000BASE-T copper SFP transceiver is a high performance, cost effective module compliant with the Gigabit Ethernet and 1000BASE-T standards as specified in IEEE 802.3-2002 and IEEE 802.3ab, which supporting 1000Mbps data rate up to 100 meters reach over unshielded twisted-pair category 5 cable. The module supports 1000 Mbps full duplex data-links with 5-level Pulse Amplitude Modulation (PAM) signals. All four pairs in the cable are used with symbol rate at 250Mbps on each pair. The 1000BASE-T copper SFP provides standard serial ID information compliant with SFP MSA, which can be accessed with address of A0h via the 2-wire serial CMOS EEPROM protocol. The physical IC can also be accessed via 2-wire serial bus at address ACh.



Applications

- 1.25 Gigabit Ethernet over Cat 5 cable
- Switch/Router to Switch/Router Link
- High speed I/O for file servers

2. Pin Assignment and Description

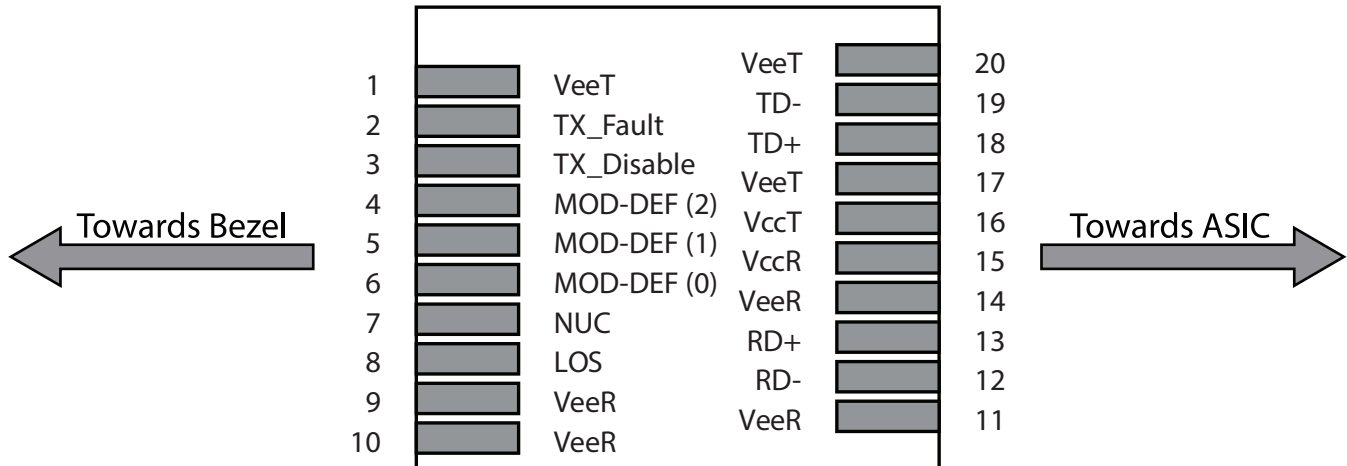

Figure 1. Host Board Connector Block Pin Numbers and Names

3. Pin Function Definitions

Pin No	Name	Function	Plug Seq	Notes
1	VeeT	Transmitter Ground	1	
2	TX Fault	Transmitter Fault Indication	3	1
3	TX Disable	Transmitter Disable	3	2
4	MOD-DEF2	Module Definition	2	3
5	MOD-DEF1	Module Definition 1	3	3
6	MOD-DEF0	Module Definition 0	3	3
7	Rate Select	Not Connected	3	
8	LOS	Loss of Signal	3	4
9	VeeR	Receiver Ground	1	
10	VeeR	Receiver Ground	1	
11	VeeR	Receiver Ground	1	
12	RD-	Inv. Received Data Out	3	5
13	RD+	Received Data Out	3	5
14	VeeR	Receiver Ground	3	
15	VccR	Receiver Power	2	6
16	VccT	Transmitter Power	2	6
17	VeeT	Transmitter Ground	1	
18	TD+	Transmit Data In	3	7
19	TD-	Inv. Transmit In	3	7
20	VeeT	Transmitter Ground	1	

Notes:

1. TX Fault is not used and is always tied to ground through a 100 ohm resistor.
2. TX Disable as described in the MSA is not applicable to the 1000BASE-T module, but is used for convenience as an input to reset the internal ASIC. This pin is pulled up within the module with a 4.7 KW resistor.
Low (0 – 0.8 V): Transceiver on Between (0.8 V and 2.0 V): Undefined
High (2.0 – 3.465 V): Transceiver in reset state
Open: Transceiver in reset state
3. Mod-Def 0,1,2. These are the module definition pins. They should be pulled up with a 4.7-10 KW resistor on the host board to a supply less than $VCCT + 0.3 V$ or $VCCR + 0.3 V$.
Mod Def 0 is tied to ground through a 100 ohm resistor to indicate that the module is present.
Mod-Def 1 is clock line of two wire serial interface for optional serial ID
Mod-Def 2 is data line of two wire serial interface for optional serial ID
4. LVTTTL compatible with a maximum voltage of 2.5V. Not supported on HTSFP-24-111X
5. RD-/+: These are the differential receiver outputs. They are ac coupled 100 ohm differential lines which should be terminated with 100 ohm differential at the user SerDes. The ac coupling is done inside the module and is thus not required on the host board. The voltage swing on these lines will be between 370 and 2000 mV differential (185 – 1000 mV single ended) when properly terminated. These levels are compatible with CML and LVPECL voltage swings.
6. VCCR and VCCT are the receiver and transmitter power supplies. They are defined as $3.3 V \pm 5\%$ at the SFP connector pin. The maximum supply current is about 300mA and the associated in-rush current will typically be no more than 30 mA above steady state after 500 nanoseconds.
7. TD-/+: These are the differential transmitter inputs. They are ac coupled differential lines with 100 W differential termination inside the module. The ac coupling is done inside the module and is thus not required on the host board. The inputs will accept differential swings of 500 – 2400 mV (250 – 1200 mV single ended), though it is recommended that values between 500 and 1200 mV differential (250 – 600 mV single ended) be used for best EMI performance. These levels are compatible with CML and LVPECL voltage swings.

4. +3.3V Volt Electrical Power Interface

This Transceiver has an input voltage range of 3.3 V +/- 5%. The 4 V maximum voltage is not allowed for continuous operation.

Parameter	Symbol	Min	Typ	Max	Units	Notes/Conditions
Supply Current	I _s		320	375	mA	1.2W max power over full range of voltage and temperature. See caution note below
Input	V _{cc}	3.13	3.3	3.47	V	Referenced to GND
Voltage Surge Current	I _{surge}		30		mA	Hot plug above steady state current. See caution note

Caution:

Power consumption and surge current are higher than the specified values in the SFP MSA

5. Low-Speed Signals

MOD_DEF(1) (SCL) and MOD_DEF(2) (SDA), are open drain CMOS signals. Both MOD_DEF(1) and MOD_DEF(2) must be pulled up to host_V_{cc}.

Parameter	Symbol	Min	Max	Units	Notes/Conditions
SFP Output LOW	V _{OL}	0	0.5	V	4.7k to 10k pull-up to host_V _{cc} .
SFP Output HIGH	V _{OH}	host_V _{cc} - 0.5	host_V _{cc} + 0.3	V	4.7k to 10k pull-up to host_V _{cc} .
SFP Input LOW	V _{IL}	0	0.8	V	4.7k to 10k pull-up to V _{cc} .
SFP Input HIGH		2	V _{cc} + 0.3 V	V	4.7k to 10k pull-up to V _{cc} .

6. High-Speed Electrical Interface

All high-speed signals are AC-coupled internally.

Parameter	Symbol	Min	Typical	Max	Units	Notes/Conditions
Transmission Line-SFP						
Line Frequency	f _L		125		MHz	5-level encoding, per IEEE 802.3
Tx Output Impedance	Z _{out,TX}		100		Ohm	Differential
Rx Input Impedance	Z _{in,RX}		100		Ohm	Differential

Parameter	Symbol	Min	Typical	Max	Units	Notes/Conditions
Host-SFP						
Single ended data input swing	Vinsing	250		1200	mV	Single ended
Single ended data output swing	Voutsing	350	100	800	mV	Single ended
Rise/Fall Time	Tr,Tf		175		psec	20%-80%
Tx Input Impedance	Zin		50		Ohm	Single ended
Rx Output Impedance	Zout		50		Ohm	Single ended

7. General Specifications

Parameter	Symbol	Min	Typical	Max	Units	Notes/Conditions
Data Rate	BR	100		1,000	Mb/s	IEEE 802.3 compatible.
Cable Length	L			100	m	Category 5 UTP. BER <10-12

8. Environmental Specifications

This transceiver has an extended range from 0°C to +85°C case temperature as specified below.

Parameter	Symbol	Min	Typ	Max	Units
Operating Temperature	Top	-0		+70	°C
Storage Temperature	Tsto	-40		100	°C

9. SFP Module EEPROM Information and Management

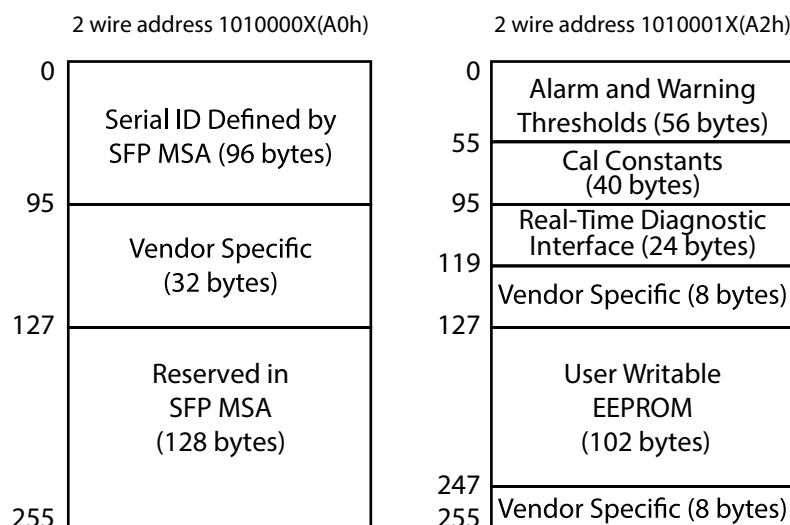

Figure 2. Diagnostic Memory Map (Specific Data Field Descriptions)

10. Serial ID Memory Contents

Base ID Fields			
Data Address	Length (Byte)	Name of Length	Description and Contents
0	1	Identifier	Type of Serial transceiver (03h=SFP)
1	1	Reserved	Extended identifier of type serial transceiver (04h)
2	1	Connector	Code of optical connector type (22=RJ45)
3-10	8	Transceiver	1000BASE - T
11	1	Encoding	8B10B (01h)
12	1	BR, Nominal	Nominal baud rate, unit of 100Mbps
13-14	2	Reserved	(0000h)
15	1	Length(9um)	Link length supported for 9/125um fiber, units of 100m
16	1	Length(50um)	Link length supported for 50/125um fiber, units of 10m
17	1	Length(62.5um)	Link length supported for 62.5/125um fiber, units of 10m
18	1	Length(Copper)	Link length supported for copper, units of meters
19	1	Reserved	
20-35	16	Vendor Name	SFP vendor name
36	1	Reserved	
37-39	3	Vendor OUI	SFP transceiver vendor OUI ID
40-55	16	Vendor PN Part Number	Part Number (ASCII)
56-59	4	Vendor rev	Revision level for part number
60-62	3	Reserved	
63	1	CCID	Least significant byte of sum of data in address 0-62
Extended ID Fields			
Data Address	Length (Byte)	Name of Length	Description and Contents
64-65	2	Option	Indicates which optical SFP signals are implemented (001Ah = LOS, TX_FAULT, TX_DISABLE all supported)
66	1	BR, max	Upper bit rate margin, units of %
67	1	BR, min	Lower bit rate margin, units of %
68-83	16	Vendor SN	Serial number (ASCII)
84-91	8	Date code	Vendor Manufacturing date code

Extended ID Fields			
Data Address	Length (Byte)	Name of Length	Description and Contents
92-94	3	Reserved	
95	1	CCEX	Check code for the extended ID Fields (addresses 64 to 94)
Vendor Specific ID Fields			
Data Address	Length (Byte)	Name of Length	Description and Contents
96-127	32	Readable	Vendor specific data, read only
128-255	128	Reserved	Reserved for SFF-8079

11. Mechanical Dimintions

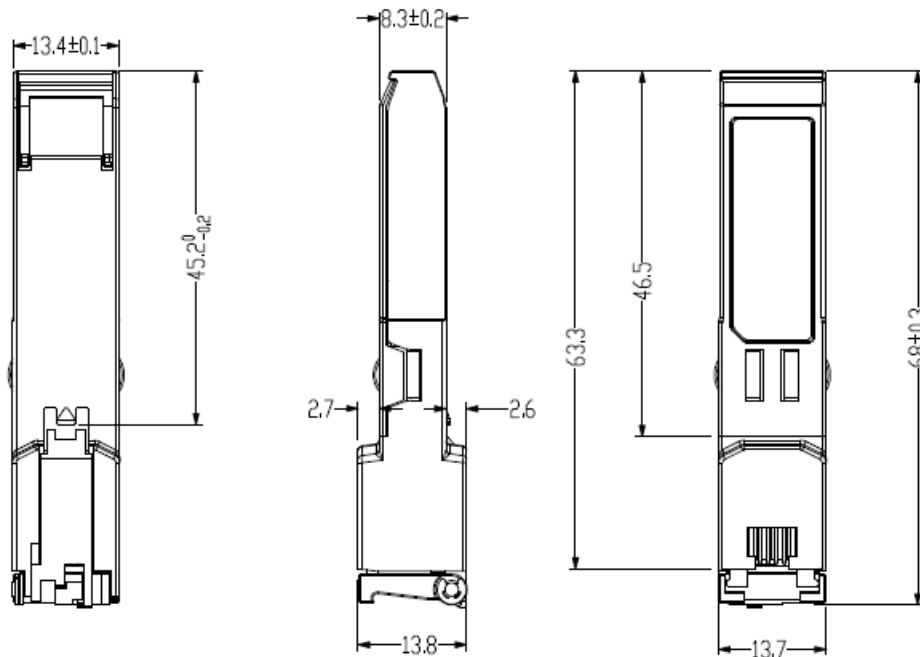

Figure 3. Mechanical outline

12. Contact Information

Approved Networks is a leading supplier of Network Transceivers and Connectivity products to Channel Partners, Resellers, and OEMs. With more than 9 years of direct industry experience, our products are resident in the most demanding and mission critical functional networks Worldwide. We serve as a Master Distributor to the largest CMs in the world and deploy the most rigorous testing and firmware management programs to bring the highest level of functional product to the market at a cost that makes sense.

Corporate Offices: **Approved Networks, Inc.**

Tel: 800.590.9535

Web: <http://www.approvednetworks.com>