

700013139-A
1GBASE, GBIC, LX Transceiver

Features

- Operating data rate up to 1.25Gbps
- 1310nm LD Transmitter
- Distance Up to 10km
- 3.3V/5V Power supply and TTL Logic Interface
- Compliant with GBIC Specification Rev5.5
- Duplex SC Connector Interface
- Hot Pluggable
- Commercial Operating Case Temperature:
0°C ~+70°C



Applications

- WDM GBE Links
- Fiber Channel Links
- SONET/SDH Equipment Interconnect

1. Description

The Approved Networks 700013139-A series optical transceivers meet the Gigabit Interface Converter (GBIC) specification Rev. 5.5. It satisfies the optical interface specifications defined in IEEE 802.3z Drift 5.0 for Gigabit Ethernet. This module is designed for Single-mode fiber and operates at a nominal wavelength of 1310 nm.

The transmitter section uses a multiple quantum well laser and is a class 1 laser compliant according to International Safety Standard IEC-60825. The receiver section uses an integrated InGaAs detector preamplifier (IDP) mounted in an optical header and a limiting post-amplifier IC. A PECL input /output logic interface is used. TTL RX-LOS output simplifies interface to external circuitry. A 20-pin SCA-2 host connector is used to connect the converter to the host system.

2. Absolute Maximum Ratings

Operation in excess of any absolute maximum ratings might cause permanent damage to this module.

Parameter	Symbol	Min	Typ	Max	Units
Storage Temperature	TS	-40		+85	°C
Power Supply Voltage	VCC	0		6	V

3. Recommended Operating Environment

Parameter	Symbol	Min	Typ	Max	Unit	
Case operating Temperature	Commercial	TC	0	-	70	°C
Supply Voltage	VCC	4.75	5	5.25	V	
		3.17	3.3	3.45		
Supply Current	Icc			300	mA	
Inrush Current	Isurge			Icc+30	mA	
Baud Rate			1.25		GBaud	

4. Performance Specifications

Transmitter						
Parameter	Symbol	Min	Typ	Max	Unit	Notes
LVPECL Inputs (Differential)	Vin	400		2500	mVp	AC coupled inputs
Input Impedance (Differential)	Zin	85	100	115	ohms	Rin > 100 kohms @ DC
Tx_DISABLE Input Voltage - High		2		Vcc+0.3	V	
Tx_DISABLE Input Voltage -Low		0		0.8	V	
Tx_FAULT Output Voltage - High		Vcc- 0.5		Vcc+0.3	V	Io = 400µA; Host Vcc
Tx_FAULT Output Voltage -Low		0		0.5	V	Io = -4.0mA
Receiver						
Parameter	Symbol	Min	Typ	Max	Unit	Notes
LVPECL Outputs (Differential)	Vout	400	800	1200	mVpp	AC coupled outputs
Output Impedance (Differential)	Zout	85	100	115	ohms	
Rx_LOS Output Voltage - High		Vcc- 0.5		Vcc+0.3	V	Io = 400µA; Host Vcc
Rx_LOS Output Voltage -Low		0		0.8	V	Io = -4.0mA
MOD_DEF (0:2)	VoH	2.5			V	With Serial ID
	VoL	0		0.5	V	

5. Optical Characteristics

Parameter	Symbol	Min	Typ	Max	Unit
9µm Core Diameter SMF		10		km	
Data Rate		1.25		Gbps	
Transmitter					
Parameter	Symbol	Min	Typ	Max	Unit
Centre Wavelength	λ_C	1270	1310	1350	nm
Spectral Width (RMS)	σ			3	nm
Average Output Power	P _{Out}	-9		-3	dBm
Extinction Ratio	EX	9			dB
Rise/Fall Time(20%~80%)	tr/tf			260	ns
Output Optical Eye	IUT-T G.957 Compliant				
Data Input Swing Differential	V _{IN}	500		2000	mV
Input Differential Impedance	Z _{IN}	90	100	110	Ω
TX Disable	Disable	2.0		VCC+0.3	V
	Enable	0		0.8	
TX_Fault	Fault	2.0		VCC+0.3	V
	Normal	0		0.8	
Tx_Disable Assert Time	t _{off}			10	us
Receiver					
Parameter	Symbol	Min	Typ	Max	Unit
Centre Wavelength	λ_C	1100		1600	nm
Receiver Sensitivity	P _{IN}			-20	dBm
Output Differential Impedance	P _{IN}	90	100	110	Ω
Data Output Swing Differential	V _{OUT}	370		2000	mV
Rise/Fall Time	Tr/tf			2.2	ns
LOS De-AssertS	LOSD			-25	dBm
LOS Assert	LOSA	-40			dBm
LOS	High	2.0		VCC+0.3	V
	Low	0		0.8	

6. Mechanical Dimentions

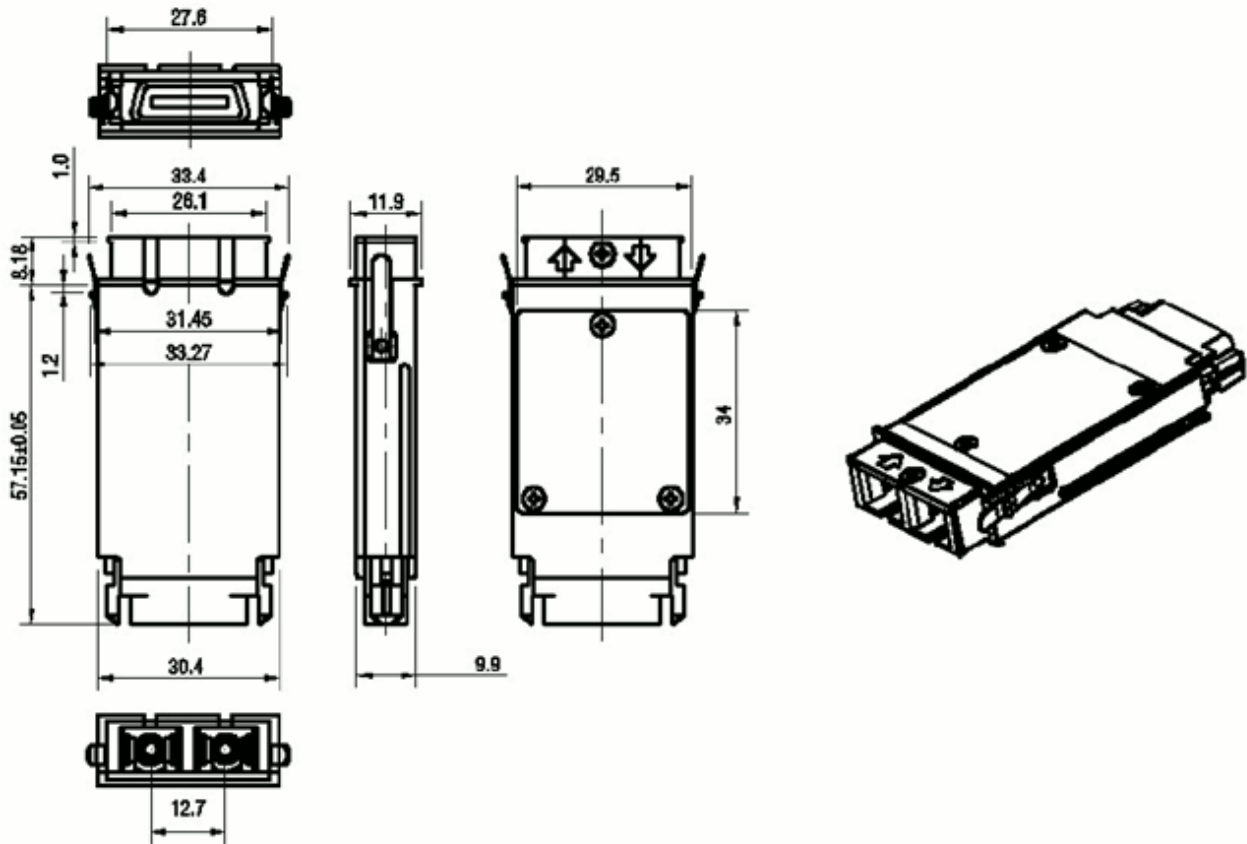

7. Regulatory Compliance

Feature	Standard	Performance
Electrostatic Discharge (ESD) to the Electrical Pins	MIL-STD-883E Method 3015.7	Class 1(>500 V) Isolation with the case
Electromagnetic Interference (EMI)	FCC Part 15 Class B	Compatible with standards
Laser Eye Safety	FDA 21CFR 1040.10 and 1040.11 EN 60950, EN (IEC) 60825-1,2	Compatible with Class I laser product. Compatible with T _μ V standards
Component Recognition	UL and CUL	UL file E317337
Green Products	RoHS	RoHS6

8. Contact Information

Approved Networks is a leading supplier of Network Transceivers and Connectivity products to Channel Partners, Resellers, and OEMs. With more than 9 years of direct industry experience, our products are resident in the most demanding and mission critical functional networks Worldwide. We serve as a Master Distributor to the largest CMs in the world and deploy the most rigorous testing and firmware management programs to bring the highest level of functional product to the market at a cost that makes sense.

Corporate Offices: **Approved Networks, Inc.**

Tel: 800.590.9535

Web: <http://www.approvednetworks.com>