

**100-02595-A**  
10GBASE, XFP, ER Transceiver

## Features

- Supports 8.0Gb/s to 11.1Gb/s bit rates
- Hot-pluggable XFP footprint, Built-in digital diagnos
- Maximum link length of 40km with SMF
- 1550nm Cooled EML laser and PIN photodiode
- XFP MSA package with duplex LC connector
- No reference clock required
- Single +3.3V power supply
- Power dissipation <3.5W
- Compatible with RoHS
- Temperature range 0 to +70°C

## 1. Description

The XFP module is compliant with the 10G Small Form-Factor Pluggable (XFP) Multi-Source Agreement (MSA), supporting data-rate of 8.0~11.1Gbps, and transmission distance up to 40km on SMF. The transceiver module comprises a transmitter with 1550nm Cooled EML laser and a receiver with a PIN photodiode. Transmitter and receiver are separate within a wide temperature range and offers optimum heat dissipation and excellent electromagnetic shielding thus enabling high port densities for 10 GbE systems.



## Applications

- SONET OC-192&SDH STM-64 at 9.953Gbps
- 10GBASE-ER/EW 10G Ethernet
- 10G Fiber Channel
- 10GE over G.709 at 11.09Gbps
- OC192 over FEC at 10.709Gbps
- Other optical links, up to 11.1Gbps

## 2. Absolute Maximum Ratings

Any stress beyond the maximum ratings can result in permanent damage. The device specifications are guaranteed only under the recommended operating conditions.

Parameter	Symbol	Min	Max	Unit
Supply Voltage	Vcc	-0.5	4.5	V
Storage Temperature	Ts	-40	+85	°C
Operating Humidity	-	5	85	%

## 3. Recommended Operating Conditions

Parameter	Symbol	Min	Typical	Max	Unit
Operating Case Temperature	Tc	0		+70	°C
Power Supply Voltage @3.3V	Vcc	3.135	3.30	3.465	V
Power Supply Current	Icc			1000	mA
Data Rate		8.0		11.1	Gbps

## 4. Optical and Electrical Characteristics

Transmitter						
Parameter	Symbol	Min	Typ	Max	Unit	Notes
Centre Wavelength	$\lambda_c$	1530	1550	1565	nm	
Spectral Width (-20dB)	$\Delta\lambda$			1	nm	
Side-Mode Suppression Ratio	SMSR	30			dB	
Average Output Power	Pout	-1		+2	dBm	1
Extinction Ratio	ER	8.2			dB	3
Data Input Swing Differential	VIN	180		950	mV	2
Input Differential Impedance	ZIN	90	100	110	$\Omega$	
TX Disable	Disable		2.0	Vcc	V	
	Enable		0	0.8	V	
Receiver						
Parameter	Symbol	Min	Typ	Max	Unit	Notes
Centre Wavelength	$\lambda_c$	1260		1600	nm	
Receiver Sensitivity				-16	dBm	3
Receiver Overload		0.5			dBm	3
LOS De-Assert	LOSD			-17	dBm	
LOS Assert	LOSA	-26			dBm	
LOS Hysteresis		0.5		4	dB	

Receiver						
Parameter	Symbol	Min	Typ	Max	Unit	Notes
Data Output Swing Differential	Vout	400	600	800	mV	2
LOS	High	2.0		Vcc	V	
	Low			0.8	V	

**Notes:**

1. The optical power is launched into SMF.
2. Internally AC-coupled.
3. Measured with a PRBS 2<sup>31</sup>-1 test pattern @9953Mbps, BER ≤1×10<sup>-12</sup>.

**5. Pin Descriptions**

Pin	Logic	Symbol	Name/Description	Notes
1		GND	Module Ground	1
2		VEE5	Optional -5.2 Power Supply – Not required	
3	LVTTL-I	Mod-Desel	Module De-select; When held low allows the module to, respond to 2-wire serial interface commands	
4	LVTTL-O	Interrupt	Interrupt (bar); Indicates presence of an important condition which can be read over the serial 2-wire interface	2
5	LVTTL-I	TX_DIS	Transmitter Disable; Transmitter laser source turned off	
6		VCC5	+5 Power Supply – Not required	
7		GND	Module Ground	1
8		VCC3	+3.3V Power Supply	
9		VCC3	+3.3V Power Supply	
10	LVTTL-I	SCL	Serial 2-wire interface clock	2
11	LVTTL- I/O	SDA	Serial 2-wire interface data line	2
12	LVTTL-O	Mod_Abs	Module Absent; Indicates module is not present. Grounded in the module.	2
13	LVTTL-O	Mod_NR	Module Not Ready;	2
14	LVTTL-O	RX_LOS	Receiver Loss of Signal indicator	2
15		GND	Module Ground	1
16		GND	Module Ground	1
17	CML-O	RD-	Receiver inverted data output	
18	CML-O	RD+	Receiver non-inverted data output	
19		GND	Module Ground	1

Pin	Logic	Symbol	Name/Description	Notes
20		VCC2	+1.8V Power Supply – Not required	
21	LVTTTL-I	P_Down/RST	Power Down; When high, places the module in the low power stand-by mode and on the falling edge of P_Down initiates a module reset Reset; The falling edge initiates a complete reset of the module including the 2-wire serial interface, equivalent to a power cycle.	
22		VCC2	+1.8V Power Supply – Not required	
23		GND	Module Ground	1
24	PECL-I	RefCLK+	Reference Clock non-inverted input, AC coupled on the host board – Not required	3
25	PECL-I	RefCLK-	Reference Clock inverted input, AC coupled on the host board – Not required	3
26		GND	Module Ground	1
27		GND	Module Ground	1
28	CML-I	TD-	Transmitter inverted data input	
29	CML-I	TD+	Transmitter non-inverted data input	
30		GND	Module Ground	1

**Notes:**

1. Module circuit ground is isolated from module chassis ground within the module.
2. Open collector, should be pulled up with 4.7k – 10k ohms on host board to a voltage between 3.15V and 3.6V.
3. A Reference Clock input is not required.

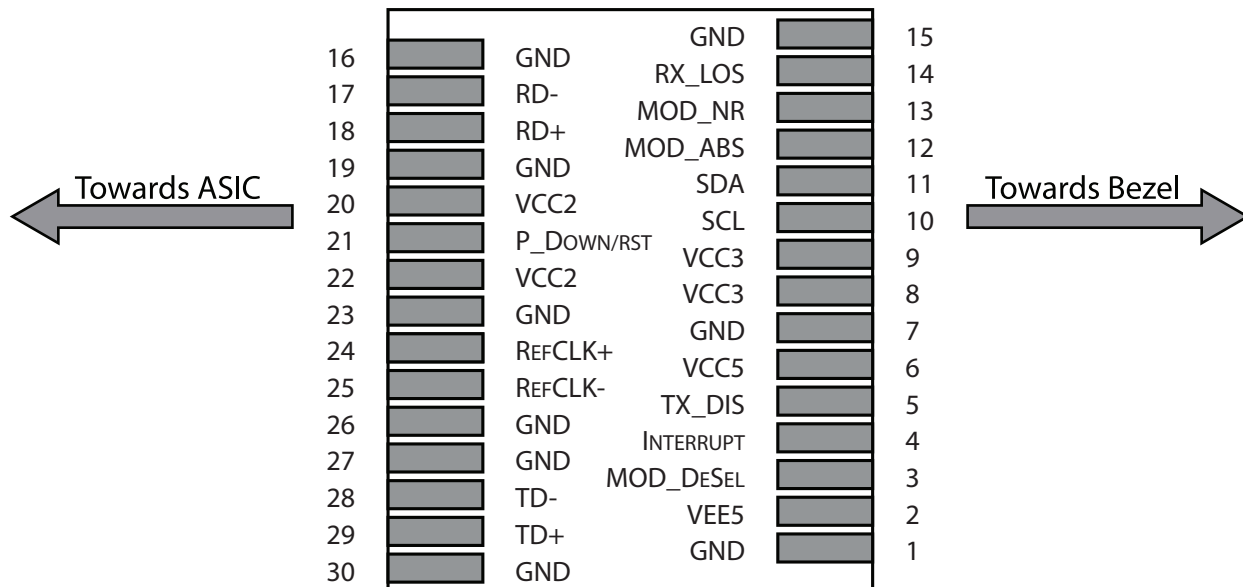

## 6. Management Interface

The transceivers provide serial ID memory contents and diagnostic information about the present operating conditions by the 2-wire serial interface (SCL, SDA).

The Module provides diagnostic information about the present operating conditions. The transceiver generates this diagnostic data by digitization of internal analog signals. Alarm/warning threshold data is written during device manufacture. Received power monitoring, transmitted power monitoring, bias current monitoring, supply voltage monitoring and temperature monitoring all are implemented.

The digital diagnostic memory map specific data field defines as following:



### 7. Recommended Host Board Power Supply Circuit



### 8. Recommended High-speed Interface Circuit

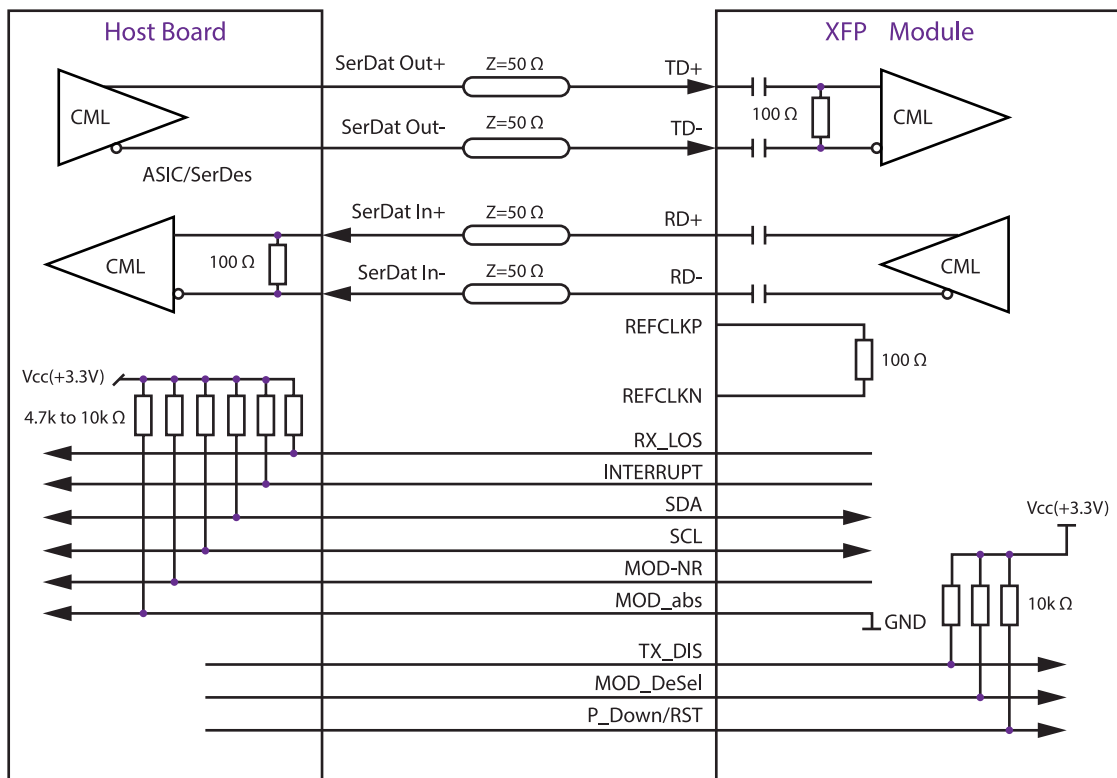

## 9. Mechanical Specifications

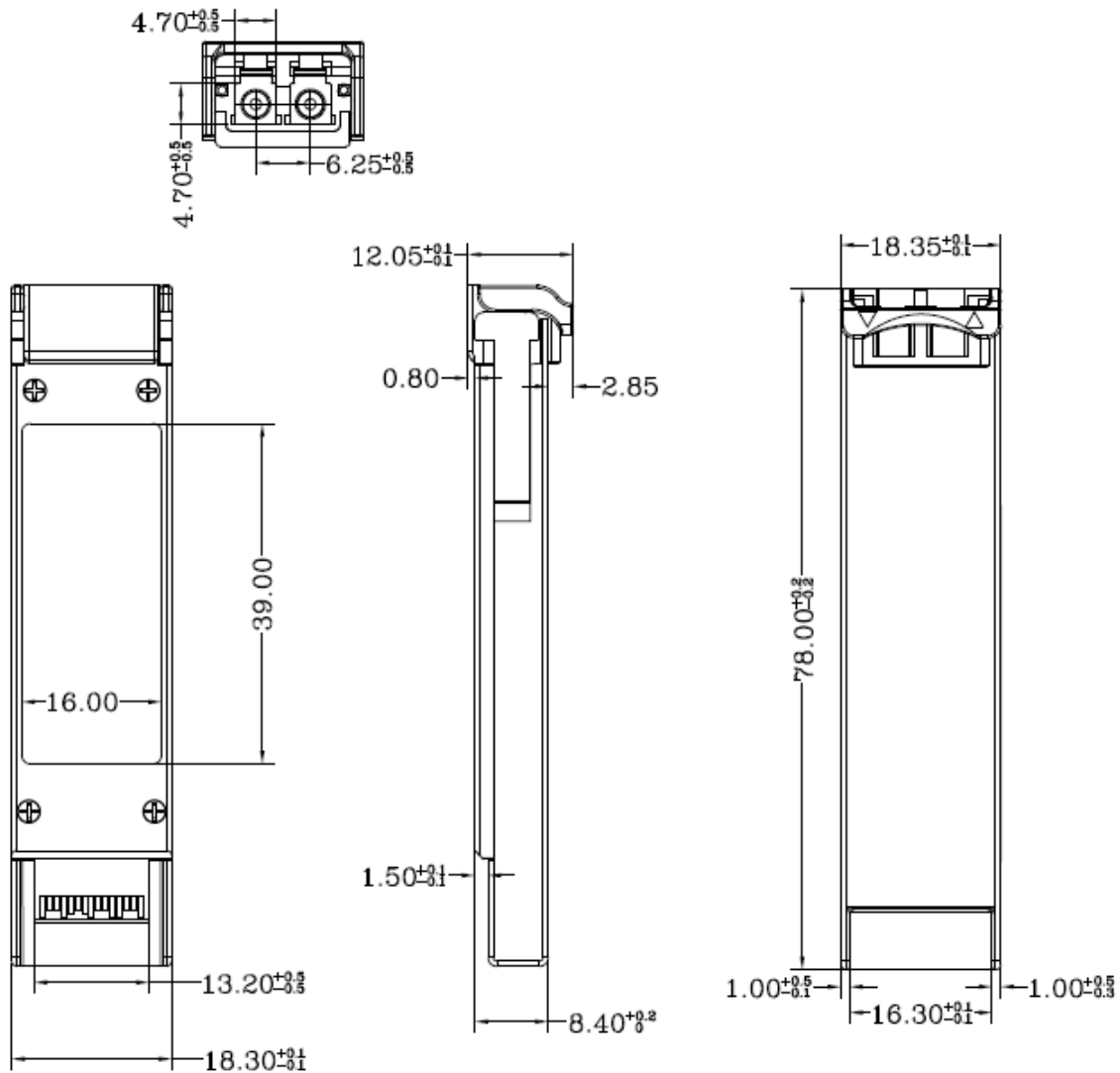

## 10. Contact Information

Approved Networks is a leading supplier of Network Transceivers and Connectivity products to Channel Partners, Resellers, and OEMs. With more than 9 years of direct industry experience, our products are resident in the most demanding and mission critical functional networks Worldwide. We serve as a Master Distributor to the largest CMs in the world and deploy the most rigorous testing and firmware management programs to bring the highest level of functional product to the market at a cost that makes sense.

Corporate Offices: **Approved Networks, Inc.**

Tel: 800.590.9535

Web: <http://www.approvednetworks.com>